



Cool box compressor MCCHD 33-45-60

-18 °C
+10 °C
Cooling

DC

12-24 V



Relax...
it's mestic®

Gebbruiksaanwijzing **NL** User instructions **EN** Bedienungsanleitung **DE** Mode d'emploi **FR**
Instrucciones de uso **ES** Istruzioni per l'uso **IT** Betjeningsvejledning **DK**
Bruksanvisning **SE** Bruksanvisning **NO**

SMART ADVENTURE



Cool box compressor MCCHD 33-45-60

**COOL BOX COMPRESSOR
MCCHD 33-45-60**

NEDERLANDS

Kenmerken

1. Handvat deksel
2. Display
3. Handvat
4. Kabelaansluiting
5. Ventilatie



Levering

1. Koelbox
2. Aansluitkabel voor 12V/24V DC
3. Gebruiksaanwijzing

Accessoires (niet inbegrepen bij de zending)

1502950 Mestic AC adapter (220-240)

Belangrijke veiligheidsvoorschriften

Bij het gebruik van elektrische apparaten moeten algemene veiligheidsvoorschriften altijd worden gevolgd om het risico op brand, elektrische schokken en/of persoonlijk letsel te beperken.

Algemene veiligheid:

- Lees voor gebruik de handleiding.
- Als de gebruiksvoorwaarden niet worden nageleefd is de fabrikant niet aansprakelijk voor schade of letsel wat is voortgekomen uit het gebruik van dit apparaat.
- Bewaar de handleiding, het garantie certificaat en de verkoop bon.
- Voor jonge kinderen is het gebruik van dit apparaat niet toegestaan. Bij gebruik moet iemand constant toezicht houden.
- Er moet toezicht gehouden worden op kinderen, zodat ze niet met het toestel gaan spelen.
- Dit apparaat is niet bedoeld om te worden gebruikt door kinderen tot 8 jaar en personen met beperkte lichamelijke, zintuiglijke of geestelijke vermogens of onvoldoende ervaring en kennis, tenzij ze worden begeleid of instructies hebben gekregen over hoe het apparaat te gebruiken door een persoon die verantwoordelijk is voor hun veiligheid.
- Het apparaat moet te allen tijden op een vlakke, stabiele en droge ondergrond staan.
- Gebruik het apparaat nooit als het zichtbaar beschadigd is of breuken in het snoer zitten.
- Bij schade aan het apparaat, het snoer of de stekker nooit zelf reparaties uit te voeren. Laat dit altijd doen door de fabrikant of een gekwalificeerde monteur.
- Het apparaat is niet geschikt voor commercieel gebruik.
- Gebruik en bewaar het apparaat altijd op een droge plek.
- Gebruik nooit accessoires die niet zijn aanbevolen vanuit de fabrikant.
- Dit apparaat is alleen geschikt voor huishoudelijk gebruik en voor het doel waar het voor bestemd is.

Veiligheid bij gebruik

- Haal altijd de stekker uit het apparaat als het onderhouden of gereinigd moet worden.
- Gebruik het apparaat nooit in de buurt van hete of warme voorwerpen.
- Voorkom dat het apparaat in aanraking komt met regen.
- Plaats geen andere elektrische apparaten in het apparaat.
- Plaats geen chemische of explosieve middelen in het apparaat.
- Gebruik uitsluitend de DC 12V of de 230V aansluitingskabel (niet meegeleverd). LET OP: gebruik nooit beide energiebronnen tegelijkertijd.
- Ontdooi het apparaat regelmatig om het apparaat optimaal te laten functioneren.
- Trek niet aan het aansluitsnoer, maar aan de stekker om het snoer uit het contact te verwijderen.
- Als de koelbox aan aangesloten is op de DC contactdoos klem uw koelbox en andere verbruikers van de accu af voor u een snel lader aansluit
- Als de koelbox aan aangesloten is op de DC contactdoos; schakel de koelbox uit of verbreek de verbinding als u de motor uitschakelt. De accu kan anders worden ontladen.
- Let op! Dat de warmte die bij de werking van de koelbox ontstaat, goed kan worden afgevoerd.
- Genoeg afstand tussen product tov voorwerpen en wanden.
- Dompel het apparaat nooit onder water
- Ventilatiesleuven te allen tijde niet worden afgedekt.

Gebruik

- Verwijder alle verpakkingsmaterialen van het apparaat.
- Plaats het apparaat op een vlakke en stabiele ondergrond met minimaal 10cm vrije ruimte aan iedere zijde.
- Schakel het apparaat niet direct in nadat u het heeft getransporteerd waarbij de koelbox meer dan 30° kanteling heeft gehad. Dit zou voor beschadigingen kunnen zorgen aan het koelsysteem. Het apparaat moet eerst 30 minuten rechtop stilstaan zodat het koelmiddel weer in de compressor kan worden opgevangen. Dit voorkomt dat de compressor droogloopt.
- Kijk voor gebruik de bovenstaande gebruikersvoorwaarden.
- Voordat u uw koelbox in gebruik neemt moet u het apparaat om hygiënische redenen van binnen en vanbuiten reinigen met een vochtige doek. (zie alinea
- Sluit de koelbox aan.

Installatie handgreep

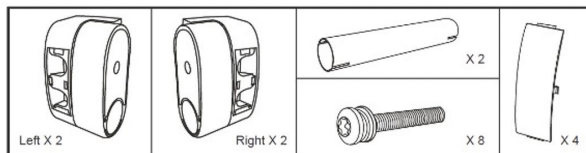

step 1

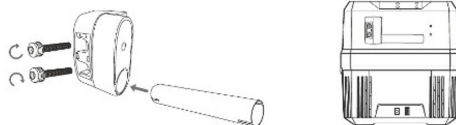

step 2

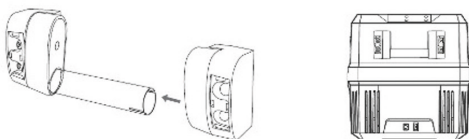

step 3

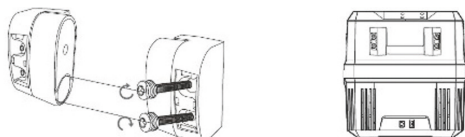

Bediening

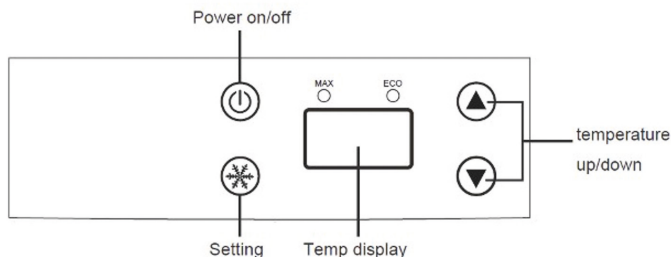

1. In en uitschakelen: houd de aan / uit-knop ingedrukt, de koelkast zal nu starten of wordt uitgeschakeld.
2. Temperatuuraanpassing: druk op de knop ▲ of ▼ om de temperatuur aan te passen De temperatuur is nu ingesteld waarna het display weer over springt naar de actuele temperatuur.
3. Snelle koeling / energiebesparende modus: Druk de instelknop ⊕ aan om snel tussen koelmodus MAX en energiebesparende modus ECO te schakelen. Green is Eco and blue is MAX
4. C naar F veranderen: Houd in de stand-bymodus de "⊕" en "▲" -toets 3 seconden ingedrukt om Fahrenheit en te wisselen Celsius temperatuur, (F is Fahrenheit temperatuur, C is Celsius temperatuur), na het loslaten van de sleutel, slaat het apparaat in 3 seconden automatisch de instelling op en sluit af.
5. Battery protectie: Druk in de standby-stand 3 seconden tegelijkertijd op "⊕" en "⊕" om de batterij in te voeren het menu voor het instellen van de batterij protectie en druk vervolgens op "▲" of "▼" om de bijbehorende batterij protectie in te stellen.

Accu bewaker

Het apparaat is voorzien van een multi-level accubewaker die uw voertuigaccu beschermt tegen overmatige ontlading wanneer het apparaat is aangesloten op de ingebouwde DC-voeding. Als de koeler wordt bediend terwijl het contact van het voertuig is uitgeschakeld, wordt de koeler uitgeschakeld automatisch zodra de voedingsspanning onder een ingesteld niveau komt. De koeler schakelt terug aan zodra de batterij is opgeladen tot het herstartspanningsniveau. De compressor start weer automatisch in een paar minuten wanneer de spanning terugkeert naar de normale waarden.

Let op: deze waarden worden gemeten op de ingang van de besturingseenheid en / of op de DC-aansluiting.

1. Batterijbeschermingsfunctie voor de koelbox met drie-klasse batterijbeschermingsfunctie, kan automatisch de batterijspanning van het voertuig controleren, voordat het elektriciteitsverbruik de normale functies van de auto zal beïnvloeden. De koelbox zal automatisch stoppen om ervoor te zorgen dat de batterij van de auto niet te leeg wordt.
2. Methode voor aanpassing van de batterijbescherming: Lees het gedeelte "bediening" hoe u het beschermingsniveau van de batterij kunt wijzigen.

Spanning / Bescherming	12V		24V	
	Laagspanning ontkoppeling	Laagspanning herkoppeling	Laagspanning ontkoppeling	Laagspanning herkoppeling
Laag	9.6V	10.9V	21.3V	22.7V
Midden	10.4V	11.7V	22.8V	24.2V
Hoog	11.1V	12.4V	24.3V	25.7V

Tip:

Het wordt aanbevolen om de H-klasse in te stellen wanneer de koelbox op een voertuig is aangesloten, anders kan de batterij van de auto te leeg zijn en de normale ontsteking van de auto beïnvloeden; Wanneer u de koelbox aansluit op een externe of back-upbatterij, wordt aanbevolen om het M-middenbereik in te stellen zodat de koelbox langer kan werken.

De betekenis van de foutcode op het scherm en hoe ermee om te gaan:

E1	Batterijspanning is laag
E2	Ventilatorstoring
E3	Opstartproblemen compressor
E4	De snelheid van de compressor voldoet niet aan de vereisten
E5	Het model raakt oververhit
E6	Module error
E7	Temperatuursensor error (open circuit of kortsluiting)

Reinigen

- Haal voor het reinigen de producten uit het apparaat en haal de stekker uit de stroomvoorziening. Reinig alleen met een lichtvochtige doek, indien nodig kan er een niet agressief schoonmaakmiddel worden gebruikt. Droog na het reinigen altijd alle natte oppervlakken met een droge doek.
- Gebruik nooit scherpe of schurende producten om het apparaat schoon te maken.
- Koelbox ontdooien: er kan zich rijp afzetten op de verdamer of binnenruimte van de koelbox door luchtvochtigheid hierdoor kan het koelvermogen verminderd worden. De koelbox dient tijdig ontdooit te worden. Als volgt:
 - Neem de producten uit de koelbox
 - Schakel het apparaat uit
 - Zet de deksel open
 - Veeg het smeltwater op of laat het smeltwater via de plug eruit lopen.



Correcte wegwerp wijze van dit product.

Dit symbool betekent dat dit product niet bij het gewone huishoudelijk afval mag worden weggegooid (2012/19/EU). Om mogelijke schade te voorkomen aan de omgeving of menselijk gezondheid van ongecontroleerd afvalverwijdering, recycle het verantwoord om duurzame hergebruik van materiële hulpbronnen te bevorderen. Om je gebruikte apparaat terug te brengen, lees de garantievoorwaarden van waar het product gekocht is. Zij kunnen het product terugnemen voor omgevingsveilige recycling.

Conformiteitsverklaring

Hiermee verklaart Gimeg Nederland B.V., dat het apparaat MCCHD 33, MCCHD 45 & MCCHD 60 voldoet aan de basiseisen en andere relevante voorschriften die in de Europese richtlijn voor elektromagnetische compatibiliteit (2014/30/EU) en laagspanningsrichtlijn (2014/35/EU) worden genoemd. Een volledige conformiteitsverklaring kunt u aanvragen op het adres dat op de achterzijde is vermeld.

	mestic®		mestic®		mestic®	
	Product name	Coolerbox	Product name	Coolerbox	Product name	Coolerbox
	Item number	MCCHD-33	Item number	MCCHD-45	Item number	MCCHD-60
	Volume	31 L	Volume	43 L	Volume	56 L
Climate classification	T. ST. SN. N	Climate classification	T. ST. SN. N	Climate classification	T. ST. SN. N	
Insulation class	◊	Insulation class	◊	Insulation class	◊	
Net weight	15.7 kg	Net weight	17.2 kg	Net weight	19 kg	
Rated Voltage DC	12V/24V ~~~	Rated Voltage DC	12V/24V ~~~	Rated Voltage DC	12V/24V ~~~	
Rated Current for DC	7.0A/3.5A	Rated Current for DC	7.0A/3.5A	Rated Current for DC	7.0A/3.5A	
Total Input Power	60W	Total Input Power	60W	Total Input Power	60W	
Refrigerant	R134a (40g)	Refrigerant	R134a (50g)	Refrigerant	R134a (60g)	
CO ₂ equiv.	0.057t	CO ₂ equiv.	0.072t	CO ₂ equiv.	0.086t	
Foam Vesicant	C-Pentane	Foam Vesicant	C-Pentane	Foam Vesicant	C-Pentane	
Order number	INK-024395	Order number	INK-024395	Order number	INK-024395	
Gimeg Nederland BV Strijkveld 27 3454 PH De Meern The Netherlands		Made in China		Made in China		

ENGLISH

Features

1. Lid handle
2. Display
3. Handle
4. Cable connection
5. Ventilation



Delivery

1. Cooler box
2. Connection cable for 12V / 24V DC
3. Instructions manual

Accessories (not included with the shipment)

1502950 Mestic AC adapter (220-240)

General Safety Instructions

Read the operating instructions carefully before putting the appliance into operation and keep the instructions including the warranty, the receipt and, if possible, the box with the internal packing. If you give this device to other people, please also pass on the operating instructions.

Algemene veiligheid:

- Read the manual before use.
- If the conditions of use are not complied with, the manufacturer will not be liable for damage or injury resulting from the use of this device.
- Save the manual, the warranty certificate and the sales receipt.
- The use of this device is not permitted for young children. During use, someone must constantly supervise.
- Children must be supervised to ensure that they do not play with the device.
- This device is not intended for use by children up to 8 years of age and persons with limited physical, sensory or mental abilities or insufficient experience and knowledge, unless they are supervised or have received instructions on how to use the device by a person responsible for their safety.
- The device must always be on a flat, stable and dry surface.
- Never use the appliance if it is visibly damaged or if there are breaks in the cord.
- In the event of damage to the appliance, the cord or the plug, never carry out repairs yourself. Always have this done by the manufacturer or a qualified technician.
- The device is not suitable for commercial use.
- Always use and store the device in a dry place.
- Never use accessories that are not recommended by the manufacturer.
- This device is only suitable for household use and for the purpose for which it is intended.

Safety in use;

- Always remove the plug from the device when it needs to be maintained or cleaned.
- Never use the device in the vicinity of hot or hot objects.
- Prevent the device from coming into contact with rain.
- Do not place other electrical devices in the device.
- Do not place chemical or explosive agents in the device.
- Only use the DC 12V or 230V connection cable (not included). NOTE: never use both energy sources at the same time.
- Defrost the device regularly to ensure that the device functions optimally.
- Do not pull on the connecting cord, but pull on the plug to remove the cord from the socket.
- If the cool box is connected to the DC socket, disconnect your cool box and other consumers from the battery before you connect a fast charger
- If the cool box is connected to the DC socket; switch off the cool box or break the connection when you switch off the engine. The battery can be discharged otherwise.
- Pay attention! That the heat that arises during the operation of the cool box can be properly dissipated.
- Enough distance between product and objects and walls.
- Never immerse the device in water
- Ventilation slots are not covered at all times.

Use

- Remove all packaging materials from the device.
- Place the device on a flat and stable surface with at least 10 cm of free space on each side.
- Do not switch the appliance on immediately after you transport it, where the cool box has been tilted more than -30 °. This could cause damage to the cooling system. The device must first stand upright for 30 minutes so that the coolant can be collected again in the compressor. This prevents the compressor from running dry.
- Look at the above user conditions before use.
- For hygienic reasons, you must clean the inside and outside of the appliance with a damp cloth before using your cool box. (see paragraph
- Connect the cooler box.

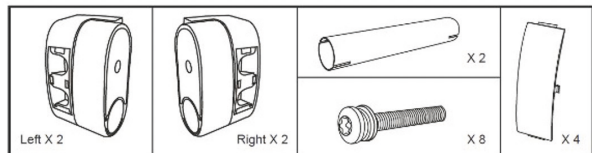
Handle installation

step 1

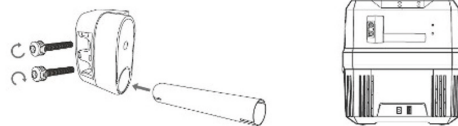

step 2

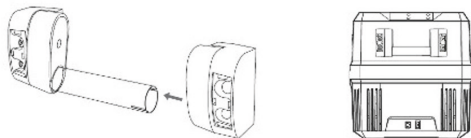

step 3



Control

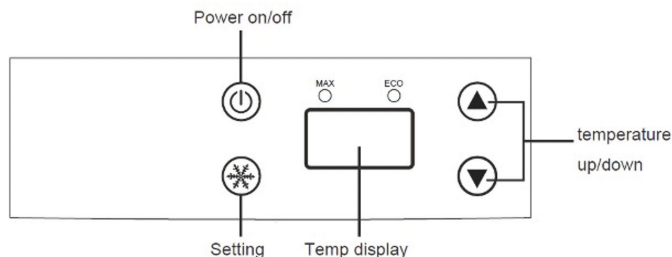

1. Switching on and off: press and hold the on / off button, the refrigerator will now start or switches off
2. Temperature adjustment: press the ▲ or ▼ button to adjust the temperature, The temperature is now set.
3. Fast cooling / energy saving mode: press the set button ⊗ to quickly switch between cooling mode MAX and energy saving mode ECO. Green is Eco and blue is MAX
4. Switch C to F: In standby mode, hold down the “⊗” and “▲” key for 3 seconds to switch Fahrenheit and Celsius temperature, (F is Fahrenheit temperature, C is Celsius temperature), after releasing the Key 3 seconds automatically save the setting and exit.
5. USB charging port: In standby state, press “⏻” and “⊗” for 3 seconds at the same time to enter the battery protection gear setting menu, and then press “▲” or “▼” to set the corresponding battery protection

Battery power detection

The device features a multi-level battery guard that protects your vehicle battery from excessive discharge when the device is connected to the built-in DC power supply. If the cooler is operated with the vehicle ignition off, the cooler will shut off automatically when the power supply voltage drops below a set level. The cooler will turn back on once the battery is charged to the restart voltage level. The compressor will restart automatically in a few minutes when the voltage returns to normal values.

Note: these values are measured at the input of the control unit and / or at the DC connection.

1. Battery protection function for the cooler with three-class battery protection function, can automatically check the battery voltage of the vehicle, before the electricity consumption will affect the normal functions of the car. The cool box will stop automatically to ensure that the car's battery does not run out.
2. Method for adjusting the battery protection:

Voltage Protection	12V		24V	
	Cut off (V)	Cut in (V)	Cut off (V)	Cut in (V)
Low	9.6V	10.9V	21.3V	22.7V
Middle	10.4V	11.7V	22.8V	24.2V
High	11.1V	12.4V	24.3V	25.7V

Tip:

It is recommended to set the H-class when the cool box is connected to a vehicle, otherwise the car's battery may be too empty and affect the normal ignition of the car; When connecting the cool box to an external or backup battery, it is recommended to set the M-mid range so that the cool box can work longer.

The meaning of the error code on the screen and how to deal with it:

E1	Battery voltage is low
E2	Fan failure
E3	Compressor start up problems
E4	Compressor's running speed fails to reach the requirements
E5	The model is overheating
E6	Module fault
E7	Thermal head fault (open circuit or short circuit)

Cleaning

- Before cleaning, remove the products from the device and remove the plug from the power supply. Only clean with a slightly damp cloth, if necessary a non-aggressive cleaning agent can be used. After cleaning, always dry all wet surfaces with a dry cloth.
- Never use sharp or abrasive products to clean the device.
- Defrost the cool box: frost can settle on the evaporator or inside of the cool box due to humidity, this can reduce the cooling capacity. The cool box must be defrosted in time. As follows
 - Take the products out of the cool box
 - Switch off the device
 - Open the lid
 - Sweep up the melt water or drain the melt water through the plug.

**Recycling**

This product bears the selective sorting symbol for waste electrical and electronic equipment. This means that this product must be handled pursuant to European Directive (2012/19/EU) in order to be recycled or dismantled to minimize its impact on the environment. For further information, please contact your local or regional authorities. Electronic products not included in the selective sorting process are potentially dangerous for the environment and human health due to the presence of hazardous substances.

Declaration of conformity

Hereby Gimeg Nederland B.V. declares that the device MCCHD 33, MCCHD 45 & MCCHD 60 applies all basic requirements and other relevant regulations listed in the European directive for electromagnetic compatibility (2014/30/EU) and low voltage directive (2014/35/EU). If you require a full declaration of conformity, you can contact the address listed on the backside of this manual

	mestic		mestic		mestic																																																																											
	<table border="1"> <thead> <tr> <th>Product name</th> <th>Coolerbox</th> </tr> </thead> <tbody> <tr> <td>Item number</td> <td>MCCHD-33</td> </tr> <tr> <td>Volume</td> <td>31 L</td> </tr> <tr> <td>Climate classification</td> <td>T. ST. SN. N</td> </tr> <tr> <td>Insulation class</td> <td>◇</td> </tr> <tr> <td>Net weight</td> <td>15.7 kg</td> </tr> <tr> <td>Rated Voltage DC</td> <td>12V/24V ---</td> </tr> <tr> <td>Rated Current for DC</td> <td>7.0A/3.5A</td> </tr> <tr> <td>Total Input Power</td> <td>60W</td> </tr> <tr> <td>Refrigerant</td> <td>R134a (40g)</td> </tr> <tr> <td>CO₂equiv.</td> <td>0.057t</td> </tr> <tr> <td>Foam Vesicant</td> <td>C-Pentane</td> </tr> <tr> <td>Order number</td> <td>INK-024395</td> </tr> </tbody> </table> <p>Made in China</p>	Product name	Coolerbox	Item number	MCCHD-33	Volume	31 L	Climate classification	T. ST. SN. N	Insulation class	◇	Net weight	15.7 kg	Rated Voltage DC	12V/24V ---	Rated Current for DC	7.0A/3.5A	Total Input Power	60W	Refrigerant	R134a (40g)	CO ₂ equiv.	0.057t	Foam Vesicant	C-Pentane	Order number	INK-024395	<table border="1"> <thead> <tr> <th>Product name</th> <th>Coolerbox</th> </tr> </thead> <tbody> <tr> <td>Item number</td> <td>MCCHD-45</td> </tr> <tr> <td>Volume</td> <td>43 L</td> </tr> <tr> <td>Climate classification</td> <td>T. ST. SN. N</td> </tr> <tr> <td>Insulation class</td> <td>◇</td> </tr> <tr> <td>Net weight</td> <td>17.2 kg</td> </tr> <tr> <td>Rated Voltage DC</td> <td>12V/24V ---</td> </tr> <tr> <td>Rated Current for DC</td> <td>7.0A/3.5A</td> </tr> <tr> <td>Total Input Power</td> <td>60W</td> </tr> <tr> <td>Refrigerant</td> <td>R134a (50g)</td> </tr> <tr> <td>CO₂equiv.</td> <td>0.072t</td> </tr> <tr> <td>Foam Vesicant</td> <td>C-Pentane</td> </tr> <tr> <td>Order number</td> <td>INK-024395</td> </tr> </tbody> </table> <p>Made in China</p>	Product name	Coolerbox	Item number	MCCHD-45	Volume	43 L	Climate classification	T. ST. SN. N	Insulation class	◇	Net weight	17.2 kg	Rated Voltage DC	12V/24V ---	Rated Current for DC	7.0A/3.5A	Total Input Power	60W	Refrigerant	R134a (50g)	CO ₂ equiv.	0.072t	Foam Vesicant	C-Pentane	Order number	INK-024395	<table border="1"> <thead> <tr> <th>Product name</th> <th>Coolerbox</th> </tr> </thead> <tbody> <tr> <td>Item number</td> <td>MCCHD-60</td> </tr> <tr> <td>Volume</td> <td>56 L</td> </tr> <tr> <td>Climate classification</td> <td>T. ST. SN. N</td> </tr> <tr> <td>Insulation class</td> <td>◇</td> </tr> <tr> <td>Net weight</td> <td>19 kg</td> </tr> <tr> <td>Rated Voltage DC</td> <td>12V/24V ---</td> </tr> <tr> <td>Rated Current for DC</td> <td>7.0A/3.5A</td> </tr> <tr> <td>Total Input Power</td> <td>60W</td> </tr> <tr> <td>Refrigerant</td> <td>R134a (60g)</td> </tr> <tr> <td>CO₂equiv.</td> <td>0.086t</td> </tr> <tr> <td>Foam Vesicant</td> <td>C-Pentane</td> </tr> <tr> <td>Order number</td> <td>INK-024395</td> </tr> </tbody> </table> <p>Made in China</p>	Product name	Coolerbox	Item number	MCCHD-60	Volume	56 L	Climate classification	T. ST. SN. N	Insulation class	◇	Net weight	19 kg	Rated Voltage DC	12V/24V ---	Rated Current for DC	7.0A/3.5A	Total Input Power	60W	Refrigerant	R134a (60g)	CO ₂ equiv.	0.086t	Foam Vesicant	C-Pentane	Order number
Product name	Coolerbox																																																																															
Item number	MCCHD-33																																																																															
Volume	31 L																																																																															
Climate classification	T. ST. SN. N																																																																															
Insulation class	◇																																																																															
Net weight	15.7 kg																																																																															
Rated Voltage DC	12V/24V ---																																																																															
Rated Current for DC	7.0A/3.5A																																																																															
Total Input Power	60W																																																																															
Refrigerant	R134a (40g)																																																																															
CO ₂ equiv.	0.057t																																																																															
Foam Vesicant	C-Pentane																																																																															
Order number	INK-024395																																																																															
Product name	Coolerbox																																																																															
Item number	MCCHD-45																																																																															
Volume	43 L																																																																															
Climate classification	T. ST. SN. N																																																																															
Insulation class	◇																																																																															
Net weight	17.2 kg																																																																															
Rated Voltage DC	12V/24V ---																																																																															
Rated Current for DC	7.0A/3.5A																																																																															
Total Input Power	60W																																																																															
Refrigerant	R134a (50g)																																																																															
CO ₂ equiv.	0.072t																																																																															
Foam Vesicant	C-Pentane																																																																															
Order number	INK-024395																																																																															
Product name	Coolerbox																																																																															
Item number	MCCHD-60																																																																															
Volume	56 L																																																																															
Climate classification	T. ST. SN. N																																																																															
Insulation class	◇																																																																															
Net weight	19 kg																																																																															
Rated Voltage DC	12V/24V ---																																																																															
Rated Current for DC	7.0A/3.5A																																																																															
Total Input Power	60W																																																																															
Refrigerant	R134a (60g)																																																																															
CO ₂ equiv.	0.086t																																																																															
Foam Vesicant	C-Pentane																																																																															
Order number	INK-024395																																																																															
<p>Gimeg Nederland BV Strijkviertel 27 3454 PH De Meern The Netherlands</p>																																																																																

DEUTSCH

Bestandteile

1. Deckelgriff
2. Display
3. Griff
4. Kabelanschluss
5. Belüftung



Lieferung

1. Kühlbox
2. Verbindungskabel für 12V / 24V DC
3. Gebrauchsanweisung

Zubehör (nicht im Lieferumfang enthalten)

1502950 Mestic AC Adapter (220-240)

Wichtige Sicherheitshinweise

Bei der Verwendung von Elektrogeräten müssen immer die allgemeinen Sicherheitsvorschriften befolgt werden, um die Gefahr von Bränden, Stromschlägen und / oder Verletzungen zu verringern.

Allgemeine Sicherheit:

- Lesen Sie vor dem Gebrauch die Bedienungsanleitung.
- Wenn die Nutzungsbedingungen nicht eingehalten werden, haftet der Hersteller nicht für Schäden oder Verletzungen, die durch die Verwendung dieses Geräts entstehen.
- Bewahren Sie das Handbuch, den Garantieschein und den Kaufbeleg auf.
- Die Verwendung dieses Geräts ist für kleine Kinder nicht gestattet. Während des Gebrauchs muss jemand ständig beaufsichtigen.
- Kinder müssen beaufsichtigt werden, um sicherzustellen, dass sie nicht mit dem Gerät spielen.
- Dieses Gerät ist nicht für Kinder bis zu 8 Jahren und Personen mit eingeschränkten körperlichen, sensorischen oder geistigen Fähigkeiten oder unzureichenden Erfahrungen und Kenntnissen bestimmt, es sei denn, sie werden von einer verantwortlichen Person beaufsichtigt oder erhalten Anweisungen zur Verwendung des Geräts ist für ihre Sicherheit.
- Das Gerät muss immer auf einer ebenen, stabilen und trockenen Oberfläche stehen.
- Verwenden Sie das Gerät niemals, wenn es sichtbar beschädigt ist oder wenn das Kabel gebrochen ist.
- Führen Sie im Falle einer Beschädigung des Geräts, des Kabels oder des Steckers niemals selbst Reparaturen durch. Lassen Sie dies immer vom Hersteller oder einem qualifizierten Techniker durchführen.
- Das Gerät ist nicht für den gewerblichen Gebrauch geeignet.
- Verwenden und lagern Sie das Gerät immer an einem trockenen Ort.
- Verwenden Sie niemals Zubehör, das nicht vom Hersteller empfohlen wird.
- Dieses Gerät ist nur für den Hausgebrauch und für den vorgesehenen Zweck geeignet.

Sicherheit im Gebrauch;

- Ziehen Sie immer den Stecker aus dem Gerät, wenn es gewartet oder gereinigt werden muss.
- Verwenden Sie das Gerät niemals in der Nähe oder in der Nähe von heißen oder heißen Gegenständen.
- Vermeiden Sie, dass das Gerät mit Regen in Berührung kommt.
- Stellen Sie keine anderen elektrischen Geräte in das Gerät.
- Geben Sie keine chemischen oder explosiven Mittel in das Gerät.
- Verwenden Sie nur das DC 12V- oder 230V-Verbindungskabel (nicht im Lieferumfang enthalten). HINWEIS: Verwenden Sie niemals beide Energiequellen gleichzeitig.
- Abtauen Sie das Gerät regelmäßig, um eine optimale Funktion des Geräts zu gewährleisten.
- Ziehen Sie nicht am Verbindungskabel, sondern am Stecker, um das Kabel aus der Steckdose zu ziehen.
- Wenn die Kühlbox an die Gleichstromsteckdose angeschlossen ist, trennen Sie die Kühlbox und andere Verbraucher von der Batterie, bevor Sie ein Schnellladegerät anschließen
- Wenn die Kühlbox an die Gleichstromsteckdose angeschlossen ist; Schalten Sie die Kühlbox aus oder trennen Sie die Verbindung, wenn Sie den Motor abstellen. Der Akku kann sonst entladen werden.
- Aufmerksamkeit schenken! Damit kann die Wärme, die beim Betrieb der Kühlbox entsteht, richtig abgeführt werden.
- Genügend Abstand zwischen Produkt und Gegenständen und Wänden.
- Tauchen Sie das Gerät niemals in Wasser
- Lüftungsschlitze sind nicht immer abgedeckt.

Gebrauch

- Entfernen Sie alle Verpackungsmaterialien vom Gerät.
- Stellen Sie das Gerät auf eine ebene und stabile Oberfläche mit mindestens 10 cm Abstand auf jeder Seite.
- Schalten Sie das Gerät nicht sofort nach dem Transport ein, wenn die Kühlbox um mehr als -30 ° geneigt ist. Dies könnte das Kühlsystem beschädigen. Das Gerät muss zunächst 30 Minuten stehen, damit sich das Kühlmittel im Kompressor wieder ansammeln kann. Dies verhindert, dass der Kompressor trocken läuft.
- Beachten Sie vor dem Gebrauch die oben genannten Nutzungsbedingungen.
- Aus hygienischen Gründen müssen Sie das Innere und Äußere des Geräts mit einem feuchten Tuch reinigen, bevor Sie Ihre Kühlbox verwenden. (siehe Absatz)
- Schließen Sie die Kühlbox an.

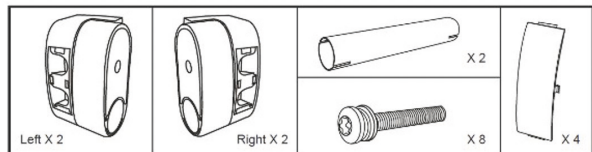
Griffmontage

step 1

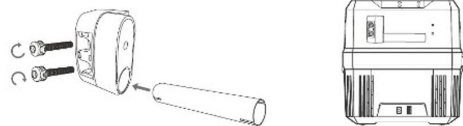

step 2

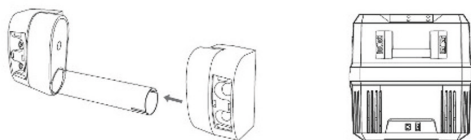

step 3



Bedienfeld

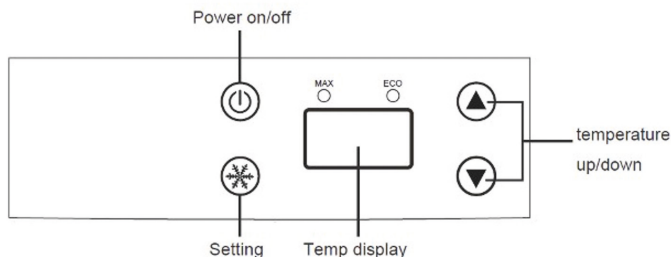

1. Ein- und Ausschalten: Halten Sie die Ein- / Aus-Taste gedrückt. Der Kühlschrank wird nun gestartet oder heruntergefahren
2. Temperatureinstellung: Drücken Sie die Taste ▲ oder ▼, um die Temperatur einzustellen. Die Temperatur ist jetzt eingestellt und das Display schaltet zurück auf die aktuelle Temperatur.
3. Schneller Kühl- / Energiesparmodus: Drücken Sie den ⊗ Empfindlichkeitsregler, um schnell zwischen dem Kühlmodus MAX und dem Energiesparmodus ECO umzuschalten. Grün ist Öko und Blau ist MAX
4. C zu F ändern: Halten Sie im Standby-Modus die Tasten ⊗ und ▲ 3 Sekunden lang gedrückt, um Fahrenheit und umzuschalten Celsius-Temperatur (F ist Fahrenheit-Temperatur, C ist Celsius-Temperatur): Nach dem Loslassen der Taste speichert das Gerät die Einstellung automatisch in 3 Sekunden und fährt herunter.
5. Batterieschutz: Drücken Sie im Standby-Modus gleichzeitig 3 Sekunden lang ⊏ und ⊗, um in den Akku zu gelangen das Menü zum Einstellen des Batterieschutzes und drücken Sie dann ▲ oder ▼, um den entsprechenden Batterieschutz einzustellen.

Batterieleistungserkennung

Das Gerät verfügt über einen mehrstufigen Batterieschutz, der Ihre Fahrzeugbatterie vor übermäßiger Entladung schützt, wenn das Gerät an die eingebaute Gleichstromversorgung angeschlossen wird. Wenn der Kühler bei ausgeschalteter Fahrzeugzündung betrieben wird, schaltet sich der Kühler automatisch aus, sobald die Versorgungsspannung unter einen festgelegten Wert fällt. Der Kühler schaltet sich wieder ein, sobald der Akku auf die Neustartspannung geladen ist. Der Kompressor startet in wenigen Minuten automatisch neu, wenn die Spannung wieder die normalen Werte erreicht.

Hinweis: Diese Werte werden am Eingang der Steuereinheit und / oder am Gleichstromanschluss gemessen.

1. Batterieschutzfunktion für die Kühlbox mit Drei-Klassen-Batterieschutzfunktion kann automatisch die Batteriespannung des Fahrzeugs prüfen, bevor der Stromverbrauch die normalen Funktionen des Fahrzeugs beeinträchtigt. Die Kühlbox stoppt automatisch, um sicherzustellen, dass die Autobatterie nicht zu leer wird.
2. Einstellmethode für den Batterieschutz: Lesen Sie den Abschnitt "Betrieb", um zu erfahren, wie Sie die Batterieschutzstufe ändern können

Spannung / Schutz	12V		24V	
	Unterspannungsabschaltung	Unterspannungswiederverbindung	Unterspannungsabschaltung	Unterspannungswiederverbindung
Niedrig	9.6V	10.9V	21.3V	22.7V
Mittel	10.4V	11.7V	22.8V	24.2V
Hoch	11.1V	12.4V	24.3V	25.7V

Hinweis:

Es wird empfohlen, die H-Klasse einzustellen, wenn die Kühlbox an ein Fahrzeug angeschlossen ist, da sonst die Autobatterie zu stark entladen und die normale Zündung des Fahrzeugs beeinträchtigt werden kann. Beim Anschluss der Kühlbox an eine externe oder Backup-Batterie empfiehlt es sich, die M-Mittelklasse einzustellen, damit die Kühlbox länger arbeiten kann.

Die Bedeutung des Fehlercodes auf dem Bildschirm und wie man damit umgeht:

E1	Batteriespannung ist niedrig
E2	Lüfterdefekt
E3	Probleme beim Starten des Kompressors
E4	Die Laufgeschwindigkeit der Kompressoren entspricht nicht den Anforderungen
E5	Das Modell überhitzt
E6	Modulfehler
E7	Thermokopffehler (leerlaufspannung oder Kurzschluss)

Reinigung

- Entfernen Sie vor dem Reinigen die Produkte aus dem Gerät und ziehen Sie den Stecker aus der Steckdose. Reinigen Sie das Gerät nur mit einem leicht feuchten Tuch. Verwenden Sie gegebenenfalls ein nicht aggressives Reinigungsmittel. Trocknen Sie nach der Reinigung alle nassen Oberflächen immer mit einem trockenen Tuch.
- Reinigen Sie das Gerät niemals mit scharfen oder scheuernden Gegenständen.
- Kühlbox abtauen: Durch Feuchtigkeit kann sich Frost am Verdampfer oder im Inneren der Kühlbox absetzen, dies kann die Kühlleistung verringern. Die Kühlbox muss rechtzeitig aufgetaut werden. Wie folgt
 - Nehmen Sie die Produkte aus der Kühlbox
 - Schalten Sie das Gerät aus
 - Öffnen Sie den Deckel
 - Das Schmelzwasser aufkehren oder das Schmelzwasser durch den Stopfen ablassen.



Richtige Einweg-Methode von dieses Produktes.

Diese Kennzeichnung zeigt an, dass dieses Gerät EU-weit nicht zusammen mit Hausmüll entsorgt werden sollte (2012/19/EU). Zur Vermeidung von möglichen Umwelt- oder Gesundheitsschäden durch unkontrollierte Abfallsorgung recyceln Sie es verantwortungsvoll zur Förderung einer nachhaltigen Wiederverwendung von Rohstoffen. Nutzen Sie bitte Rückgabe- und Sammelsysteme oder wenden Sie sich an den Einzelhändler, bei dem sie das Gerät erworben haben, um es zurückzugeben. So kann das Gerät umweltschonend recycelt werden.

Konformitätserklärung

Hiermit erklärt die Firma Gimeg Nederland B.V., dass sich das Gerät MCCHD 33, MCCHD 45, MCCHD 60 in Übereinstimmung mit den grundlegenden Anforderungen, der europäischen Richtlinie für elektromagnetische Verträglichkeit (2014/30/EU) und der Niederspannungsrichtlinie (2014/35/EU) befindet. Brauchen Sie eine völlige Konformitätserklärung, bitte nehmen Sie Kontakt auf mit die Adresse am Rückseite diese Bedienungshinweise

	<p style="text-align: center;">mestic</p> <table border="1"> <thead> <tr> <th>Product name</th> <th>Coolerbox</th> </tr> </thead> <tbody> <tr> <td>Item number</td> <td>MCCHD-33</td> </tr> <tr> <td>Volume</td> <td>31 L</td> </tr> <tr> <td>Climate classification</td> <td>T. ST. SN. N</td> </tr> <tr> <td>Insulation class</td> <td>◇◇</td> </tr> <tr> <td>Net weight</td> <td>15.7 kg</td> </tr> <tr> <td>Rated Voltage DC</td> <td>12V/24V ---</td> </tr> <tr> <td>Rated Current for DC</td> <td>7.0A/3.5A</td> </tr> <tr> <td>Total Input Power</td> <td>60W</td> </tr> <tr> <td>Refrigerant</td> <td>R134a (40g)</td> </tr> <tr> <td>CO₂equiv.</td> <td>0.057t</td> </tr> <tr> <td>Foam Vesciant</td> <td>C-Pentane</td> </tr> <tr> <td>Order number</td> <td>INK-024395</td> </tr> </tbody> </table> <p>Made in China</p>	Product name	Coolerbox	Item number	MCCHD-33	Volume	31 L	Climate classification	T. ST. SN. N	Insulation class	◇◇	Net weight	15.7 kg	Rated Voltage DC	12V/24V ---	Rated Current for DC	7.0A/3.5A	Total Input Power	60W	Refrigerant	R134a (40g)	CO ₂ equiv.	0.057t	Foam Vesciant	C-Pentane	Order number	INK-024395	<p style="text-align: center;">mestic</p> <table border="1"> <thead> <tr> <th>Product name</th> <th>Coolerbox</th> </tr> </thead> <tbody> <tr> <td>Item number</td> <td>MCCHD-45</td> </tr> <tr> <td>Volume</td> <td>43 L</td> </tr> <tr> <td>Climate classification</td> <td>T. ST. SN. N</td> </tr> <tr> <td>Insulation class</td> <td>◇◇◇</td> </tr> <tr> <td>Net weight</td> <td>17.2 kg</td> </tr> <tr> <td>Rated Voltage DC</td> <td>12V/24V ---</td> </tr> <tr> <td>Rated Current for DC</td> <td>7.0A/3.5A</td> </tr> <tr> <td>Total Input Power</td> <td>60W</td> </tr> <tr> <td>Refrigerant</td> <td>R134a (50g)</td> </tr> <tr> <td>CO₂equiv.</td> <td>0.072t</td> </tr> <tr> <td>Foam Vesciant</td> <td>C-Pentane</td> </tr> <tr> <td>Order number</td> <td>INK-024395</td> </tr> </tbody> </table> <p>Made in China</p>	Product name	Coolerbox	Item number	MCCHD-45	Volume	43 L	Climate classification	T. ST. SN. N	Insulation class	◇◇◇	Net weight	17.2 kg	Rated Voltage DC	12V/24V ---	Rated Current for DC	7.0A/3.5A	Total Input Power	60W	Refrigerant	R134a (50g)	CO ₂ equiv.	0.072t	Foam Vesciant	C-Pentane	Order number	INK-024395	<p style="text-align: center;">mestic</p> <table border="1"> <thead> <tr> <th>Product name</th> <th>Coolerbox</th> </tr> </thead> <tbody> <tr> <td>Item number</td> <td>MCCHD-60</td> </tr> <tr> <td>Volume</td> <td>56 L</td> </tr> <tr> <td>Climate classification</td> <td>T. ST. SN. N</td> </tr> <tr> <td>Insulation class</td> <td>◇◇◇</td> </tr> <tr> <td>Net weight</td> <td>19 kg</td> </tr> <tr> <td>Rated Voltage DC</td> <td>12V/24V ---</td> </tr> <tr> <td>Rated Current for DC</td> <td>7.0A/3.5A</td> </tr> <tr> <td>Total Input Power</td> <td>60W</td> </tr> <tr> <td>Refrigerant</td> <td>R134a (60g)</td> </tr> <tr> <td>CO₂equiv.</td> <td>0.086t</td> </tr> <tr> <td>Foam Vesciant</td> <td>C-Pentane</td> </tr> <tr> <td>Order number</td> <td>INK-024395</td> </tr> </tbody> </table> <p>Made in China</p>	Product name	Coolerbox	Item number	MCCHD-60	Volume	56 L	Climate classification	T. ST. SN. N	Insulation class	◇◇◇	Net weight	19 kg	Rated Voltage DC	12V/24V ---	Rated Current for DC	7.0A/3.5A	Total Input Power	60W	Refrigerant	R134a (60g)	CO ₂ equiv.	0.086t	Foam Vesciant	C-Pentane	Order number	INK-024395
	Product name	Coolerbox																																																																															
Item number	MCCHD-33																																																																																
Volume	31 L																																																																																
Climate classification	T. ST. SN. N																																																																																
Insulation class	◇◇																																																																																
Net weight	15.7 kg																																																																																
Rated Voltage DC	12V/24V ---																																																																																
Rated Current for DC	7.0A/3.5A																																																																																
Total Input Power	60W																																																																																
Refrigerant	R134a (40g)																																																																																
CO ₂ equiv.	0.057t																																																																																
Foam Vesciant	C-Pentane																																																																																
Order number	INK-024395																																																																																
Product name	Coolerbox																																																																																
Item number	MCCHD-45																																																																																
Volume	43 L																																																																																
Climate classification	T. ST. SN. N																																																																																
Insulation class	◇◇◇																																																																																
Net weight	17.2 kg																																																																																
Rated Voltage DC	12V/24V ---																																																																																
Rated Current for DC	7.0A/3.5A																																																																																
Total Input Power	60W																																																																																
Refrigerant	R134a (50g)																																																																																
CO ₂ equiv.	0.072t																																																																																
Foam Vesciant	C-Pentane																																																																																
Order number	INK-024395																																																																																
Product name	Coolerbox																																																																																
Item number	MCCHD-60																																																																																
Volume	56 L																																																																																
Climate classification	T. ST. SN. N																																																																																
Insulation class	◇◇◇																																																																																
Net weight	19 kg																																																																																
Rated Voltage DC	12V/24V ---																																																																																
Rated Current for DC	7.0A/3.5A																																																																																
Total Input Power	60W																																																																																
Refrigerant	R134a (60g)																																																																																
CO ₂ equiv.	0.086t																																																																																
Foam Vesciant	C-Pentane																																																																																
Order number	INK-024395																																																																																
<p>DC12024V</p> <p>Control panel</p> <p>Display control panel</p> <p>Module</p> <p>F1 F2 F3 F4 F5 F6</p> <p>Gimeg Nederland B/V Strijkvierfel 27 3454 PH De Meern The Netherlands</p> <p>CE</p>																																																																																	

FRANÇAIS

Caractéristiques

1. Poignée du couvercle
2. Affichage
3. Poignée
4. Connexion par câble
5. Aération



Livraison

1. Glacière
2. Câble de connexion pour 12V / 24V DC
3. Manuel d'instructions

Accessoires (non inclus avec l'envoi)

1502950 Adaptateur secteur (220-240)

Consignes générales de sécurité

Lisez les consignes de fonctionnement avant de mettre l'appareil en marche et de garder ou de jeter le manuel d'utilisation, la garantie, le reçu ou encore le carton ainsi que son contenu. Si vous donnez ce dispositif à d'autres personnes, veuillez également leur fournir le manuel d'utilisation.

Sécurité générale:

- Lisez le manuel avant utilisation.
- Si les conditions d'utilisation ne sont pas respectées, le fabricant ne pourra être tenu responsable des dommages ou des blessures résultant de l'utilisation de cet appareil.
- Conservez le manuel, le certificat de garantie et le reçu.
- L'utilisation de ce dispositif n'est pas autorisée pour les jeunes enfants. Pendant l'utilisation, une personne doit constamment surveiller.
- Les enfants doivent être surveillés pour s'assurer qu'ils ne jouent pas avec l'appareil.
- Cet appareil n'est pas destiné à être utilisé par des enfants jusqu'à 8 ans et des personnes ayant des capacités physiques, sensorielles ou mentales limitées ou une expérience et des connaissances insuffisantes, sauf si elles sont supervisées ou ont reçu des instructions sur la façon d'utiliser l'appareil par une personne responsable. est pour leur sécurité.
- L'appareil doit toujours être sur une surface plane, stable et sèche.
- N'utilisez jamais l'appareil s'il est visiblement endommagé ou s'il y a des ruptures dans le cordon.
- En cas de dommage à l'appareil, au cordon ou à la fiche, n'effectuez jamais de réparation vous-même. Faites-le toujours par le fabricant ou par un technicien qualifié.
- L'appareil n'est pas adapté à un usage commercial.
- Utilisez et stockez toujours l'appareil dans un endroit sec.
- N'utilisez jamais d'accessoires non recommandés par le fabricant.
- Cet appareil est uniquement destiné à un usage domestique et à l'usage auquel il est destiné.

Sécurité d'utilisation;

- Débranchez toujours la fiche de l'appareil lorsqu'il doit être entretenu ou nettoyé.
- N'utilisez jamais l'appareil à proximité d'objets chauds ou brûlants.
- Évitez tout contact de l'appareil avec la pluie.
- Ne placez pas d'autres appareils électriques dans l'appareil.
- Ne placez aucun agent chimique ou explosif dans l'appareil.
- Utilisez uniquement le câble de connexion DC 12V ou 230V (non fourni). REMARQUE: n'utilisez jamais les deux sources d'énergie en même temps.
- Dégivrez l'appareil régulièrement pour garantir un fonctionnement optimal de l'appareil.
- Ne tirez pas sur le cordon de connexion, mais tirez sur la fiche pour retirer le cordon de la prise.
- Si la glacière est connectée à la prise CC, débranchez la glacière et les autres consommateurs de la batterie avant de brancher un chargeur rapide.
- Si la glacière est connectée à la prise CC; Éteignez la glacière ou interrompez la connexion lorsque vous éteignez le moteur. La batterie peut être déchargée autrement.
- Faites attention! La chaleur dégagée lors du fonctionnement de la glacière peut être dissipée correctement.
- Assez de distance entre le produit et les objets et les murs.
- Ne plongez jamais l'appareil dans l'eau
- Les fentes d'aération ne sont pas toujours couvertes.

Utilisation

- Retirez tous les matériaux d'emballage de l'appareil.
- Placez l'appareil sur une surface plane et stable avec au moins 10 cm d'espace libre de chaque côté.
- N'allumez pas l'appareil immédiatement après l'avoir transporté lorsque la glacière a été inclinée à plus de -30°. Cela pourrait endommager le système de refroidissement. L'appareil doit d'abord rester debout pendant 30 minutes pour que le liquide de refroidissement puisse être récupéré dans le compresseur. Cela empêche le compresseur de fonctionner à sec.
- Regardez les conditions d'utilisation ci-dessus avant utilisation.
- Pour des raisons d'hygiène, vous devez nettoyer l'intérieur et l'extérieur de l'appareil avec un chiffon humide avant d'utiliser votre glacière. (voir paragraphe
- Connectez la glacière.

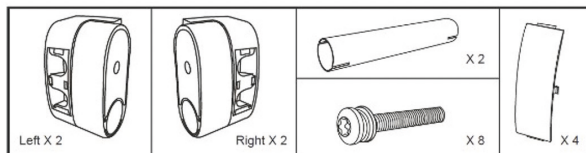
Poignée d'installation

step 1

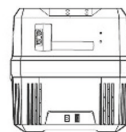
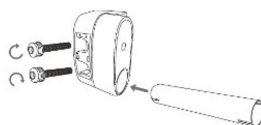

step 2

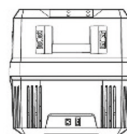
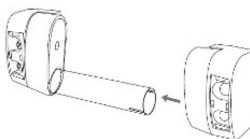

step 3

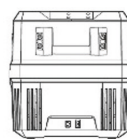
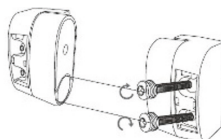

Un service

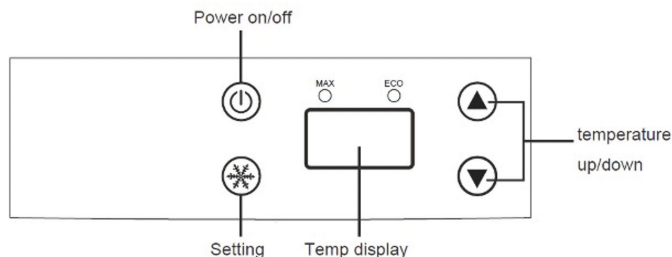

1. Allumer et éteindre: appuyez et maintenez le bouton marche / arrêt, le réfrigérateur va maintenant démarrer ou s'éteindre
2. Réglage de la température: appuyez ▲ sur ▼ le bouton ou pour régler la température, la température est maintenant réglée.
3. Mode refroidissement rapide / économie d'énergie: appuyez sur le bouton de réglage ⚙ pour basculer rapidement entre le mode refroidissement MAX et le mode économie d'énergie ECO. Le vert est Eco et le bleu est MAX
4. Commutez C à F: En mode veille, maintenez les touches "⊕" et "▲" enfoncées pendant 3 secondes pour changer Fahrenheit et Température Celsius, (F est la température Fahrenheit, C est la température Celsius), après avoir relâché la La touche 3 secondes enregistre automatiquement le réglage et quitte.
5. Port de charge USB: en état de veille, appuyez sur "⏻" et "⚙" pendant 3 secondes en même temps pour entrer dans la batterie menu de réglage de l'équipement de protection, puis appuyez sur "▲" ou "▼" pour régler la batterie correspondante protection

Détection de la puissance de la batterie

L'appareil dispose d'un protège-batterie à plusieurs niveaux qui protège la batterie de votre véhicule contre une décharge excessive lorsque l'appareil est connecté à l'alimentation CC intégrée. Si le refroidisseur est utilisé avec le contact du véhicule coupé, le refroidisseur s'éteint automatiquement lorsque la tension d'alimentation chute en dessous d'un niveau défini. Le refroidisseur se rallumera une fois que la batterie sera chargée au niveau de tension de redémarrage. Le compresseur redémarrera automatiquement dans quelques minutes lorsque la tension reviendra aux valeurs normales.

Remarque: ces valeurs sont mesurées à l'entrée de l'unité de commande et / ou au raccordement DC.

1. Fonction de protection de la batterie pour le refroidisseur avec fonction de protection de la batterie à trois classes, peut vérifier automatiquement la tension de la batterie du véhicule, avant que la consommation d'électricité n'affecte les fonctions normales de la voiture. La glacière s'arrêtera automatiquement pour s'assurer que la batterie de la voiture ne s'épuise pas.
2. Méthode de réglage de la protection de la batterie:

Protection \ Tension	12V		24V	
	Déconnexion basse tension	Recouplage basse tension	Déconnexion basse tension	Recouplage basse tension
Bas	9.6V	10.9V	21.3V	22.7V
Milieu	10.4V	11.7V	22.8V	24.2V
Haute	11.1V	12.4V	24.3V	25.7V

Conseil:

Il est recommandé de régler la classe H lorsque la glacière est connectée à un véhicule, sinon la batterie de la voiture risque d'être trop vide et d'affecter l'allumage normal de la voiture. Lorsque vous connectez la glacière à une batterie externe ou à une pile de secours, il est recommandé de régler la plage M-mid afin que la glacière puisse fonctionner plus longtemps.

La signification du code d'erreur à l'écran et comment y remédier:

E1	La tension de la batterie est faible
E2	Panne du ventilateur
E3	Problèmes de démarrage du compresseur
E4	La vitesse du compresseur ne répond pas aux exigences
E5	Le modèle surchauffe
E6	Défaut module
E7	Défaut de capteur thermique (circuit ouvert ou court-circuit)

Nettoyage

- Avant le nettoyage, retirez les produits de l'appareil et débranchez la prise d'alimentation. Nettoyez uniquement avec un chiffon légèrement humide. Si nécessaire, utilisez un détergent non agressif. Après le nettoyage, séchez toujours toutes les surfaces humides avec un chiffon sec.
- N'utilisez jamais de produits pointus ou abrasifs pour nettoyer l'appareil.
- Dégivrez la glacière: du fait de l'humidité, le givre peut se déposer sur l'évaporateur ou à l'intérieur de la glacière, ce qui peut réduire la capacité de refroidissement. La glacière doit être décongelée à temps. Comme suit
 - Sortez les produits de la glacière
 - éteindre l'appareil
 - Ouvrez le couvercle
 - Balayez l'eau de fonte ou drainez l'eau de fonte à travers le bouchon.

**Recyclage**

Ce produit porte le symbole de tri sélectif pour le matériel électrique et électronique de rebut. Cela signifie que le produit doit être manipulé conformément à la Directive (2012/19/EU) du Parlement européen relative aux déchets d'équipements électriques et électroniques. Pour des informations complémentaires, contactez vos autorités locales ou régionales. Les produits électroniques non inclus dans le processus de tri sélectif sont potentiellement dangereux pour l'environnement et la santé humaine en raison de la présence de substances dangereuses.

Déclaration de conformité

Commandes Gimeg Pays-Bas B.V. déclare que l'appareil MCCHD33, MCCHD 45 MCCHD 60 applique à toutes les exigences de base et autres règlements pertinents énumérés dans la directive européenne sur la compatibilité électromagnétique (2014/30/EU) et la directive basse tension (2014/35/EU). Si vous avez besoin d'une déclaration de conformité

	mestic		mestic		mestic																																																																											
	<table border="1"> <thead> <tr> <th>Product name</th> <th>Coolerbox</th> </tr> </thead> <tbody> <tr> <td>Item number</td> <td>MCCHD-33</td> </tr> <tr> <td>Volume</td> <td>31 L</td> </tr> <tr> <td>Climate classification</td> <td>T. ST. SN. N</td> </tr> <tr> <td>Insulation class</td> <td>◇◇</td> </tr> <tr> <td>Net weight</td> <td>15.7 kg</td> </tr> <tr> <td>Rated Voltage DC</td> <td>12V/24V ---</td> </tr> <tr> <td>Rated Current for DC</td> <td>7.0A/3.5A</td> </tr> <tr> <td>Total Input Power</td> <td>60W</td> </tr> <tr> <td>Refrigerant</td> <td>R134a (40g)</td> </tr> <tr> <td>CO₂equiv.</td> <td>0.057t</td> </tr> <tr> <td>Foam Vesicant</td> <td>C-Pentane</td> </tr> <tr> <td>Order number</td> <td>INK-024395</td> </tr> </tbody> </table> <p>Made in China</p>	Product name	Coolerbox	Item number	MCCHD-33	Volume	31 L	Climate classification	T. ST. SN. N	Insulation class	◇◇	Net weight	15.7 kg	Rated Voltage DC	12V/24V ---	Rated Current for DC	7.0A/3.5A	Total Input Power	60W	Refrigerant	R134a (40g)	CO ₂ equiv.	0.057t	Foam Vesicant	C-Pentane	Order number	INK-024395	<table border="1"> <thead> <tr> <th>Product name</th> <th>Coolerbox</th> </tr> </thead> <tbody> <tr> <td>Item number</td> <td>MCCHD-45</td> </tr> <tr> <td>Volume</td> <td>43 L</td> </tr> <tr> <td>Climate classification</td> <td>T. ST. SN. N</td> </tr> <tr> <td>Insulation class</td> <td>◇◇</td> </tr> <tr> <td>Net weight</td> <td>17.2 kg</td> </tr> <tr> <td>Rated Voltage DC</td> <td>12V/24V ---</td> </tr> <tr> <td>Rated Current for DC</td> <td>7.0A/3.5A</td> </tr> <tr> <td>Total Input Power</td> <td>60W</td> </tr> <tr> <td>Refrigerant</td> <td>R134a (50g)</td> </tr> <tr> <td>CO₂equiv.</td> <td>0.072t</td> </tr> <tr> <td>Foam Vesicant</td> <td>C-Pentane</td> </tr> <tr> <td>Order number</td> <td>INK-024395</td> </tr> </tbody> </table> <p>Made in China</p>	Product name	Coolerbox	Item number	MCCHD-45	Volume	43 L	Climate classification	T. ST. SN. N	Insulation class	◇◇	Net weight	17.2 kg	Rated Voltage DC	12V/24V ---	Rated Current for DC	7.0A/3.5A	Total Input Power	60W	Refrigerant	R134a (50g)	CO ₂ equiv.	0.072t	Foam Vesicant	C-Pentane	Order number	INK-024395	<table border="1"> <thead> <tr> <th>Product name</th> <th>Coolerbox</th> </tr> </thead> <tbody> <tr> <td>Item number</td> <td>MCCHD-60</td> </tr> <tr> <td>Volume</td> <td>56 L</td> </tr> <tr> <td>Climate classification</td> <td>T. ST. SN. N</td> </tr> <tr> <td>Insulation class</td> <td>◇◇</td> </tr> <tr> <td>Net weight</td> <td>19 kg</td> </tr> <tr> <td>Rated Voltage DC</td> <td>12V/24V ---</td> </tr> <tr> <td>Rated Current for DC</td> <td>7.0A/3.5A</td> </tr> <tr> <td>Total Input Power</td> <td>60W</td> </tr> <tr> <td>Refrigerant</td> <td>R134a (60g)</td> </tr> <tr> <td>CO₂equiv.</td> <td>0.086t</td> </tr> <tr> <td>Foam Vesicant</td> <td>C-Pentane</td> </tr> <tr> <td>Order number</td> <td>INK-024395</td> </tr> </tbody> </table> <p>Made in China</p>	Product name	Coolerbox	Item number	MCCHD-60	Volume	56 L	Climate classification	T. ST. SN. N	Insulation class	◇◇	Net weight	19 kg	Rated Voltage DC	12V/24V ---	Rated Current for DC	7.0A/3.5A	Total Input Power	60W	Refrigerant	R134a (60g)	CO ₂ equiv.	0.086t	Foam Vesicant	C-Pentane	Order number
Product name	Coolerbox																																																																															
Item number	MCCHD-33																																																																															
Volume	31 L																																																																															
Climate classification	T. ST. SN. N																																																																															
Insulation class	◇◇																																																																															
Net weight	15.7 kg																																																																															
Rated Voltage DC	12V/24V ---																																																																															
Rated Current for DC	7.0A/3.5A																																																																															
Total Input Power	60W																																																																															
Refrigerant	R134a (40g)																																																																															
CO ₂ equiv.	0.057t																																																																															
Foam Vesicant	C-Pentane																																																																															
Order number	INK-024395																																																																															
Product name	Coolerbox																																																																															
Item number	MCCHD-45																																																																															
Volume	43 L																																																																															
Climate classification	T. ST. SN. N																																																																															
Insulation class	◇◇																																																																															
Net weight	17.2 kg																																																																															
Rated Voltage DC	12V/24V ---																																																																															
Rated Current for DC	7.0A/3.5A																																																																															
Total Input Power	60W																																																																															
Refrigerant	R134a (50g)																																																																															
CO ₂ equiv.	0.072t																																																																															
Foam Vesicant	C-Pentane																																																																															
Order number	INK-024395																																																																															
Product name	Coolerbox																																																																															
Item number	MCCHD-60																																																																															
Volume	56 L																																																																															
Climate classification	T. ST. SN. N																																																																															
Insulation class	◇◇																																																																															
Net weight	19 kg																																																																															
Rated Voltage DC	12V/24V ---																																																																															
Rated Current for DC	7.0A/3.5A																																																																															
Total Input Power	60W																																																																															
Refrigerant	R134a (60g)																																																																															
CO ₂ equiv.	0.086t																																																																															
Foam Vesicant	C-Pentane																																																																															
Order number	INK-024395																																																																															
<p>Gimeg Nederland BV Strijkviertel 27 3454 PH De Meern The Netherlands</p>																																																																																

Características

1. Asa de la tapa
2. Pantalla
3. Asa
4. Conexión del cable
5. Ventilación



Suministro

1. Nevera
2. Cable de conexión para 12 V / 24 VCC
3. Manual de utilización

Accesorios (no incluidos con el suministro)

1502950 Adaptador Mestic de C.A. (220 - 240)

Instrucciones generales de seguridad

Lea atentamente las instrucciones de funcionamiento antes de poner en marcha el aparato y guarde las instrucciones, incluida la garantía, el recibo y, si es posible, la caja con el embalaje interno. Si le da este aparato a otra persona, entregue también las instrucciones de funcionamiento.

Seguridad General:

- Lea el manual antes de utilizar el aparato.
- Si no se cumplen las condiciones de utilización, el fabricante no se hace responsable de los daños o lesiones resultantes del uso de este aparato.
- Guarde este manual, el certificado de garantía y el recibo de compra.
- No se permite el uso de este aparato por niños pequeños. Durante su utilización, alguien debe supervisar de forma constante.
- Los niños deben ser supervisados para asegurarse de que no jueguen con el aparato.
- Este aparato no está diseñado para que lo utilicen niños menores de 8 años de edad y personas con capacidades físicas, sensoriales o mentales limitadas o experiencia y conocimientos insuficientes, a menos que estén supervisados o hayan recibido instrucciones sobre cómo utilizar el aparato por parte de una persona responsable de su seguridad.
- El aparato debe estar siempre sobre una superficie plana, estable y seca.
- Nunca utilice el aparato si hay daños o roturas en el cable.
- En caso de avería del aparato, el cable o enchufe, nunca realice reparaciones usted mismo. Haga que esto siempre lo lleve a cabo el fabricante o un técnico cualificado.
- Este aparato no es apto para uso comercial.
- Siempre utilice y guarde el aparato en un lugar seco.
- Nunca utilice accesorios que no sean los recomendados por el fabricante.
- Este aparato solo es apto para uso doméstico y para el propósito para el que está destinado.

Seguridad durante la utilización:

- Siempre desconecte el enchufe de alimentación del aparato si se le va a dar mantenimiento o limpiar.
- No utilice nunca el aparato cerca de objetos calientes.
- Evite que el aparato entre en contacto con la lluvia.
- No coloque otros aparatos eléctricos en el aparato.
- No ponga agentes químicos o explosivos en el aparato.
- Utilícelo solamente con un cable de conexión de 12 VCC o 230 VCA (no se incluye). NOTA: no utilice nunca ambas fuentes de energía al mismo tiempo.
- Descongele la nevera periódicamente para mantener las funciones del aparato en estado óptimo.
- No tire del cable de conexión sino del conector para desenchufarlo.
- Si la nevera está conectada a la toma de CC, desconéctela y desconecte otros aparatos que consuman la batería antes de conectar un cargador rápido.
- Si la nevera está conectada a la toma de CC, apague la nevera o desconéctela cuando apague el motor. Si no lo hace, se podría descargar la batería.
- ¡Preste atención! El calor que se produce durante el funcionamiento de la nevera debe poder disiparse correctamente.
- Deje una distancia suficiente entre el aparato, otros objetos y las paredes.
- Nunca sumerja el aparato en el agua.
- Las ranuras de ventilación no están cubiertas en todo momento.

Utilización

- Retire todos los materiales de embalaje del aparato.
- Ponga el aparato sobre una superficie plana y estable con al menos 10 cm de espacio libre a cada lado.
- No encienda el aparato inmediatamente después de transportarlo, si la nevera se ha inclinado más de -30 °. Se podría dañar el sistema de refrigeración. El aparato debe dejarse en posición vertical durante al menos 30 minutos, de modo que el refrigerante pueda recolectarse nuevamente en el compresor. Esto evitará que el compresor funcione en vacío.
- Consulte las condiciones de utilización indicadas antes de utilizar el aparato.
- Por razones de higiene, debe limpiar el interior y exterior del aparato con un paño húmedo antes de utilizar la nevera. (Vea el apartado
- Conecte la nevera.

Instalación del asa

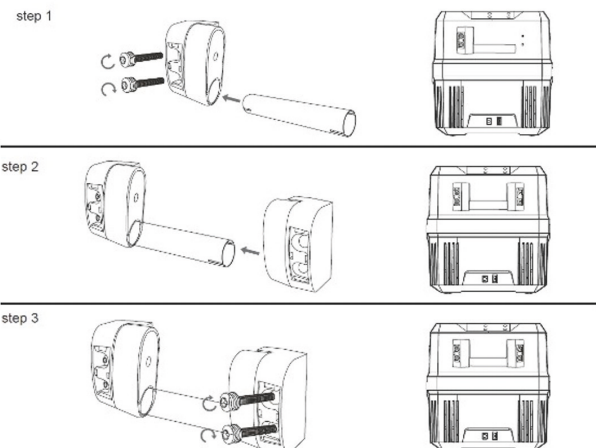
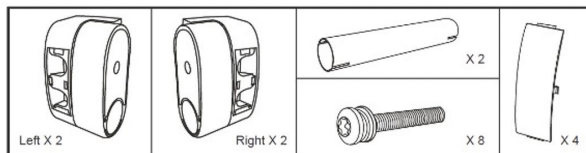

Control

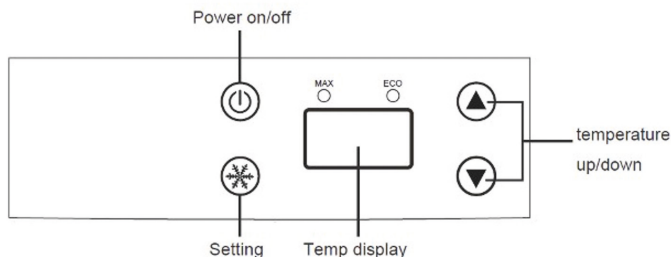

1. Encendido y apagado: pulse y mantenga pulsado el botón de encendido / apagado para poner en marcha y apagar la nevera
2. Ajuste de temperatura: pulse el botón ▲ o ▼ para regular la temperatura. Ahora quedará establecida la temperatura.
3. Modo de refrigeración rápida / ahorro de energía: pulse el botón de programación ⊗ para cambiar rápidamente entre el modo de refrigeración MÁX. y el modo de ahorro de energía ECO. Verde indica ECO y azul indica MÁX.
4. Cambiar C a F: En el modo de espera, mantenga pulsada la tecla "⊗" y "▲" durante 3 segundos para cambiar la temperatura Fahrenheit y Celsius (F es la temperatura Fahrenheit, C es la temperatura Celsius), luego de soltar la tecla 3 segundos guarda automáticamente la configuración y sale.
5. Puerto de carga USB: En el modo de espera, pulse "⏏" y "⊗" durante 3 segundos al mismo tiempo para ir al menú del sistema de protección de la batería, y luego pulse "▲" o "▼" para configurar la protección de la batería correspondiente.

Detección de alimentación con batería

El aparato cuenta con un protector de batería de varios niveles que protege la batería de su vehículo de una descarga excesiva cuando

el aparato está conectado a la fuente de alimentación de CC. Si se utiliza la nevera con el vehículo apagado, la nevera se apagará automáticamente cuando la tensión de alimentación caiga de un nivel determinado. La nevera volverá a encenderse cuando

la batería esté cargada al nivel de tensión de reinicio. El compresor se reiniciará automáticamente en unos minutos cuando el voltaje vuelva a los valores normales.

Nota: estos valores se miden en la entrada de la unidad de control y / o en la conexión de CC.

1. La función de protección de la batería de la nevera dispone de tres clases, puede verificar automáticamente el voltaje de la batería del vehículo, antes de que el consumo de electricidad afecte las funciones normales del automóvil. La nevera se detendrá automáticamente para garantizar que la batería del automóvil no se agote.
2. Método de ajuste de protección de la batería:

Protección \ Voltaje	12 V		24 V	
	Desconexión (V)	Conexión (V)	Desconexión (V)	Conexión (V)
Bajo	9,6 V	10,9 V	21,3 V	22,7 V
Medio	10,4 V	11,7 V	22,8 V	24,2 V
Alto	11,1 V	12,4 V	24,3 V	25,7 V

Sugerencia:

Se recomienda configurar la clase H si la nevera se conecta a un vehículo, de lo contrario, la batería del automóvil puede estar demasiado baja y afectar al arranque normal del automóvil; al conectar la nevera a una batería externa o de respaldo, se recomienda configurar el rango M-medio para que la nevera pueda funcionar durante más tiempo.

Significado de los códigos de error en pantalla y qué hacer:

E1	La carga de la batería es baja
E2	Fallo del ventilador
E3	Problemas de arranque del compresor
E4	La velocidad de funcionamiento del compresor no cumple los requisitos
E5	Sobrecalentamiento
E6	Fallo del módulo
E7	Fallo del cabezal térmico (circuito abierto o cortocircuito)

Limpieza

- Antes de limpiar, retire los productos del aparato y desconecte el enchufe de la fuente de alimentación. Limpie solo con un paño ligeramente húmedo, si es necesario se puede utilizar un agente de limpieza no agresivo. Después de la limpieza, seque siempre todas las superficies mojadas con un paño seco.
- No utilice nunca productos cortantes o abrasivos para limpiar el aparato.
- Descongelar la nevera: la escarcha puede depositarse en el evaporador o dentro de la nevera debido a la humedad, esto puede reducir la capacidad de refrigeración. Debe descongelar la nevera periódicamente. Como se indica:
 - Retire los productos de la nevera
 - Apague la nevera
 - Abra la tapa
 - Absorba el agua líquida o drene a través del tapón.



Reciclaje

Este producto lleva el símbolo de clasificación selectiva para residuos de equipos eléctricos y electrónicos. Esto significa que este producto debe manipularse de acuerdo con la Directiva europea (2012/19/EU) para su reciclaje y desmontaje, minimizando así su impacto en el medio ambiente. Para obtener más información, póngase en contacto con las autoridades locales o regionales. Los productos electrónicos no incluidos en el proceso de clasificación selectiva son potencialmente peligrosos para el medio ambiente y la salud humana debido a la presencia de sustancias peligrosas.

Declaración de conformidad

Por la presente, Gimeg Nederland B.V. declara que el dispositivo MCCHD 33, MCCHD 45 y MCCHD 60 cumple todos los requisitos básicos y otras regulaciones relevantes enumeradas en la directiva europea de compatibilidad electromagnética (2014/30/EU) y la directiva de baja tensión (2014/35/EU). Si necesita una declaración de conformidad completa, puede comunicarse con la dirección que figura en la parte posterior de este manual.

	mestic	mestic	mestic																																																																																			
	<table border="1"> <tr><th>Product name</th><td>Coolerbox</td></tr> <tr><th>Item number</th><td>MCCHD-33</td></tr> <tr><th>Volume</th><td>31 L</td></tr> <tr><th>Climate classification</th><td>T. ST. SN. N</td></tr> <tr><th>Insulation class</th><td>◇◇</td></tr> <tr><th>Net weight</th><td>15.7 kg</td></tr> <tr><th>Rated Voltage DC</th><td>12V/24V ---</td></tr> <tr><th>Rated Current for DC</th><td>7.0A/3.5A</td></tr> <tr><th>Total Input Power</th><td>60W</td></tr> <tr><th>Refrigerant</th><td>R134a (40g)</td></tr> <tr><th>CO₂equiv.</th><td>0.057t</td></tr> <tr><th>Foam Vesciant</th><td>C-Pentane</td></tr> <tr><th>Order number</th><td>INK-024395</td></tr> <tr><td colspan="2">Made in China</td></tr> </table>	Product name	Coolerbox	Item number	MCCHD-33	Volume	31 L	Climate classification	T. ST. SN. N	Insulation class	◇◇	Net weight	15.7 kg	Rated Voltage DC	12V/24V ---	Rated Current for DC	7.0A/3.5A	Total Input Power	60W	Refrigerant	R134a (40g)	CO ₂ equiv.	0.057t	Foam Vesciant	C-Pentane	Order number	INK-024395	Made in China		<table border="1"> <tr><th>Product name</th><td>Coolerbox</td></tr> <tr><th>Item number</th><td>MCCHD-45</td></tr> <tr><th>Volume</th><td>43 L</td></tr> <tr><th>Climate classification</th><td>T. ST. SN. N</td></tr> <tr><th>Insulation class</th><td>◇◇◇</td></tr> <tr><th>Net weight</th><td>17.2 kg</td></tr> <tr><th>Rated Voltage DC</th><td>12V/24V ---</td></tr> <tr><th>Rated Current for DC</th><td>7.0A/3.5A</td></tr> <tr><th>Total Input Power</th><td>60W</td></tr> <tr><th>Refrigerant</th><td>R134a (50g)</td></tr> <tr><th>CO₂equiv.</th><td>0.072t</td></tr> <tr><th>Foam Vesciant</th><td>C-Pentane</td></tr> <tr><th>Order number</th><td>INK-024395</td></tr> <tr><td colspan="2">Made in China</td></tr> </table>	Product name	Coolerbox	Item number	MCCHD-45	Volume	43 L	Climate classification	T. ST. SN. N	Insulation class	◇◇◇	Net weight	17.2 kg	Rated Voltage DC	12V/24V ---	Rated Current for DC	7.0A/3.5A	Total Input Power	60W	Refrigerant	R134a (50g)	CO ₂ equiv.	0.072t	Foam Vesciant	C-Pentane	Order number	INK-024395	Made in China		<table border="1"> <tr><th>Product name</th><td>Coolerbox</td></tr> <tr><th>Item number</th><td>MCCHD-60</td></tr> <tr><th>Volume</th><td>56 L</td></tr> <tr><th>Climate classification</th><td>T. ST. SN. N</td></tr> <tr><th>Insulation class</th><td>◇◇◇◇</td></tr> <tr><th>Net weight</th><td>19 kg</td></tr> <tr><th>Rated Voltage DC</th><td>12V/24V ---</td></tr> <tr><th>Rated Current for DC</th><td>7.0A/3.5A</td></tr> <tr><th>Total Input Power</th><td>60W</td></tr> <tr><th>Refrigerant</th><td>R134a (60g)</td></tr> <tr><th>CO₂equiv.</th><td>0.086t</td></tr> <tr><th>Foam Vesciant</th><td>C-Pentane</td></tr> <tr><th>Order number</th><td>INK-024395</td></tr> <tr><td colspan="2">Made in China</td></tr> </table>	Product name	Coolerbox	Item number	MCCHD-60	Volume	56 L	Climate classification	T. ST. SN. N	Insulation class	◇◇◇◇	Net weight	19 kg	Rated Voltage DC	12V/24V ---	Rated Current for DC	7.0A/3.5A	Total Input Power	60W	Refrigerant	R134a (60g)	CO ₂ equiv.	0.086t	Foam Vesciant	C-Pentane	Order number	INK-024395	Made in China
Product name	Coolerbox																																																																																					
Item number	MCCHD-33																																																																																					
Volume	31 L																																																																																					
Climate classification	T. ST. SN. N																																																																																					
Insulation class	◇◇																																																																																					
Net weight	15.7 kg																																																																																					
Rated Voltage DC	12V/24V ---																																																																																					
Rated Current for DC	7.0A/3.5A																																																																																					
Total Input Power	60W																																																																																					
Refrigerant	R134a (40g)																																																																																					
CO ₂ equiv.	0.057t																																																																																					
Foam Vesciant	C-Pentane																																																																																					
Order number	INK-024395																																																																																					
Made in China																																																																																						
Product name	Coolerbox																																																																																					
Item number	MCCHD-45																																																																																					
Volume	43 L																																																																																					
Climate classification	T. ST. SN. N																																																																																					
Insulation class	◇◇◇																																																																																					
Net weight	17.2 kg																																																																																					
Rated Voltage DC	12V/24V ---																																																																																					
Rated Current for DC	7.0A/3.5A																																																																																					
Total Input Power	60W																																																																																					
Refrigerant	R134a (50g)																																																																																					
CO ₂ equiv.	0.072t																																																																																					
Foam Vesciant	C-Pentane																																																																																					
Order number	INK-024395																																																																																					
Made in China																																																																																						
Product name	Coolerbox																																																																																					
Item number	MCCHD-60																																																																																					
Volume	56 L																																																																																					
Climate classification	T. ST. SN. N																																																																																					
Insulation class	◇◇◇◇																																																																																					
Net weight	19 kg																																																																																					
Rated Voltage DC	12V/24V ---																																																																																					
Rated Current for DC	7.0A/3.5A																																																																																					
Total Input Power	60W																																																																																					
Refrigerant	R134a (60g)																																																																																					
CO ₂ equiv.	0.086t																																																																																					
Foam Vesciant	C-Pentane																																																																																					
Order number	INK-024395																																																																																					
Made in China																																																																																						
<p>Gimeg Nederland B.V. Strijkvierdt 27 3454 PH De Meern The Netherlands</p>																																																																																						

Caratteristiche

1. Maniglia del coperchio
2. Display
3. Maniglia
4. Collegamento del cavo
5. Ventilazione



Erogazione

1. Frigorifero
2. Cavo di collegamento per 12 V / 24 V CC
3. Manuale di istruzioni

Accessori (non forniti in dotazione)

1502950 Adattatore CA Mestic (220-240)

Istruzioni generali per la sicurezza

Leggere attentamente le istruzioni per l'uso prima di mettere in funzione l'apparecchio e conservare le istruzioni comprese la garanzia, lo scontrino e, se possibile, la confezione con l'imballaggio interno. Se si cede questo dispositivo ad altre persone, trasmettere anche le istruzioni per l'uso.

Sicurezza generale:

- Leggere il manuale prima dell'uso.
- Se le condizioni d'uso non vengono rispettate, il produttore non è responsabile di danni o lesioni derivanti dall'uso di questo dispositivo.
- Conservare il manuale, il certificato di garanzia e la ricevuta di acquisto.
- L'uso di questo dispositivo non è consentito ai bambini piccoli. Se le condizioni d'uso non vengono rispettate, il produttore non sarà responsabile per danni o lesioni derivanti dall'uso di questo dispositivo.
- I bambini devono essere controllati per garantire che non giochino con il dispositivo.
- Questo dispositivo non deve essere usato da bambini di età inferiore a 8 anni e persone con capacità fisiche, sensoriali o mentali ridotte, o prive di esperienza e conoscenza, a meno che non abbiano ricevuto una supervisione o istruzioni sull'uso del dispositivo da parte di una persona responsabile della loro sicurezza.
- Il dispositivo deve essere sempre collocato su una superficie piana, stabile e asciutta.
- Non utilizzare mai l'apparecchio se è visibilmente danneggiato e se il cavo presenta rotture.
- In caso di danni all'apparecchio, al cavo o alla spina, non effettuare mai riparazioni da soli. Per eseguire questa operazione, rivolgersi al produttore o a un tecnico qualificato.
- Il dispositivo non è adatto per l'uso commerciale.
- Utilizzare e conservare sempre il dispositivo in un luogo asciutto.
- Non utilizzare mai accessori non consigliati dal produttore.
- Questo dispositivo è adatto solo all'uso domestico e allo scopo per il quale è previsto.

Sicurezza in uso;

- Rimuovere sempre la spina di alimentazione dal dispositivo in caso di manutenzione o pulizia.
- Non utilizzare mai il dispositivo in prossimità di oggetti caldi o tiepidi.
- Evitare che il dispositivo venga a contatto con la pioggia.
- Non collocare altri dispositivo elettrici all'interno del dispositivo.
- Non inserire prodotti chimici o esplosivi nel dispositivo.
- Utilizzare esclusivamente il cavo di collegamento a 12 V CC o 230 V (non incluso). NOTA: non utilizzare mai contemporaneamente entrambe le fonti di energia.
- Sbrinare periodicamente il dispositivo per garantire un funzionamento ottimale.
- Non tirare il cavo di collegamento, ma tirare la spina per rimuovere il cavo dalla presa.
- Se il frigorifero portatile è collegato alla presa CC, scollegare il frigorifero e le altre utenze dalla batteria prima di collegare un caricatore rapido.
- Se il frigorifero è collegato alla presa CC, spegnere il frigorifero o interrompere il collegamento quando si spegne il motore. In caso contrario, la batteria potrebbe scaricarsi.
- Attenzione! Il calore che si sviluppa durante il funzionamento del frigorifero deve essere adeguatamente dissipato.
- Garantire una distanza sufficiente tra prodotto e oggetti e pareti.
- Non immergere mai il dispositivo in acqua.
- Le fessure di ventilazione non devono essere mai coperte.

Uso

- Rimuovere tutti i materiali di imballaggio dal dispositivo.
- Collocare il dispositivo su una superficie piana e stabile con almeno 10 cm di spazio libero su ciascun lato.
- Non accendere l'apparecchio subito il trasporto, in quanto il frigorifero è stato inclinato di oltre -30°. Ciò potrebbe causare danni al sistema di raffreddamento. Il dispositivo deve prima rimanere in posizione verticale per 30 minuti in modo che il refrigerante possa essere nuovamente raccolto nel compressore. Ciò impedisce la marcia a secco del compressore.
- Osservare le condizioni d'uso sopra riportate prima dell'uso.
- Per motivi igienici, è necessario pulire l'interno e l'esterno dell'apparecchio con un panno umido prima di utilizzare il frigorifero. (vedere il paragrafo
- Collegare il frigorifero.

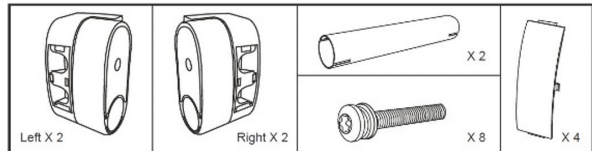
Installazione della maniglia

step 1

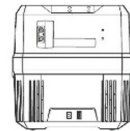
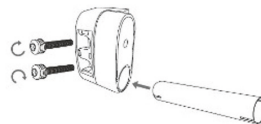

step 2

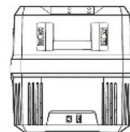
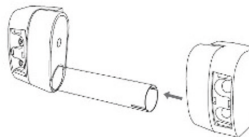

step 3

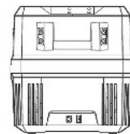
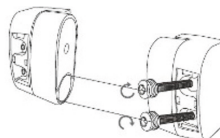

Controllo

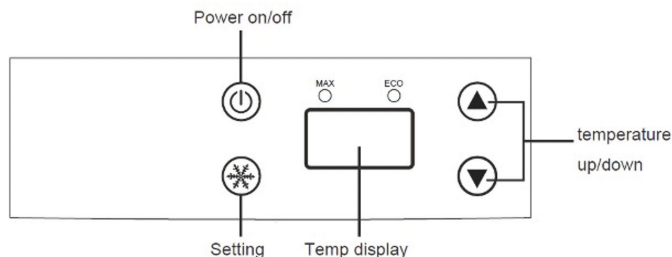

1. Accensione e spegnimento: tenendo premuto il tasto di accensione/spegnimento, il frigorifero si avvia o si spegne.
2. Regolazione della temperatura: premere il tasto ▲ o ▼ per regolare la temperatura. La temperatura viene quindi impostata.
3. Modalità di raffreddamento rapido/risparmio energetico: premere il tasto di impostazione ☼ per passare rapidamente dalla modalità di raffreddamento MAX alla modalità di risparmio energetico ECO. Il verde indica Eco, mentre il blu MAX.
4. Commutazione da C a F: In modalità standby, tenere premuti i tasti "☼" e "▲" per 3 secondi per cambiare la temperatura Fahrenheit e Celsius (F è la temperatura Fahrenheit, C è la temperatura Celsius). Dopo aver rilasciato il tasto per 3 secondi, si salva automaticamente l'impostazione e si esce.
5. Porte di carica USB: Nello stato di standby, premere "☼" e "☼" per 3 secondi contemporaneamente per accedere al menu di impostazione del dispositivo di protezione della batteria, quindi premere "▲" o "▼" per impostare la protezione della batteria corrispondente.

Rilevamento alimentazione a batteria

Il dispositivo è dotato di una protezione della batteria multilivello che protegge la batteria del veicolo da un'eccessiva scarica quando il dispositivo è collegato all'alimentatore CC in dotazione. Se il frigorifero viene utilizzato con l'accensione del veicolo disinserita, il frigorifero si spegne automaticamente quando la tensione di alimentazione scende al di sotto di un livello impostato. Il frigorifero si riaccende una volta che la batteria viene caricata al livello di tensione di riavvio. Il compressore si riavvia automaticamente in pochi minuti quando la tensione torna ai valori normali.

Nota: questi valori vengono misurati sull'ingresso della centralina e/o sul collegamento CC.

1. La funzione di protezione della batteria per il frigorifero con funzione di protezione della batteria a tre classi può controllare automaticamente la tensione della batteria del veicolo, prima che il consumo di elettricità influisca sulle normali funzioni dell'auto. Il frigorifero si arresta automaticamente per garantire che la batteria dell'auto non si esaurisca.
2. Metodo per la regolazione della protezione della batteria:

Tensione / Protezione	12 V		24 V	
	Cut off (V)	Cut in (V)	Cut off (V)	Cut in (V)
Basso	9,6 V	10,9 V	21,3 V	22,7 V
Medio	10,4 V	11,7 V	22,8 V	24,2 V
Alto	11,1 V	12,4 V	24,3 V	25,7 V

Suggerimento:

Si consiglia di impostare la classe H quando il frigorifero è collegato a un veicolo, altrimenti la batteria dell'auto potrebbe essere troppo scarica e compromettere la normale accensione dell'auto; quando si collega il frigorifero a una batteria esterna o di riserva, si consiglia di impostare la gamma M-mid in modo che il frigorifero possa funzionare più a lungo.

Significato del codice di errore sullo schermo e come risolverlo:

E1	La tensione della batteria è bassa
E2	Guasto ventola
E3	Problemi di avvio del compressore
E4	La velocità di funzionamento del compressore non raggiunge i requisiti
E5	Surriscaldamento del modello
E6	Guasto del modulo
E7	Guasto testina termica (circuito interrotto o cortocircuito)

Pulizia

- Prima della pulizia, rimuovere i prodotti dal dispositivo e rimuovere la spina dall'alimentatore. Pulire solo con un panno leggermente umido. Se necessario, è possibile utilizzare un detergente non aggressivo. Dopo la pulizia, asciugare sempre tutte le superfici bagnate con un panno asciutto.
- Non utilizzare mai prodotti taglienti o abrasivi per pulire il dispositivo.
- Sbrinamento del frigorifero: potrebbe depositarsi brina sull'evaporatore o all'interno del frigorifero a causa dell'umidità. Ciò può ridurre la capacità di raffreddamento. Il frigorifero deve essere scongelato in tempo come segue:
 - Estrarre i prodotti dal frigorifero
 - Spegner il dispositivo
 - Aprire il coperchio
 - Raccogliere l'acqua di fusione o drenare l'acqua di fusione attraverso il tappo.

**Riciclo**

Questo prodotto è contrassegnato dal simbolo per la cernita selettiva per i rifiuti di apparecchiature elettriche ed elettroniche. Ciò significa che questo prodotto deve essere maneggiato in conformità alla Direttiva europea (2012/19/EU) al fine di essere riciclato o smontato per ridurre al minimo l'impatto sull'ambiente. Per ulteriori informazioni, rivolgersi alle autorità locali o regionali. I prodotti elettronici non inclusi nel processo di cernita selettiva sono potenzialmente pericolosi per l'ambiente e la salute umana a causa della presenza di sostanze pericolose.

Dichiarazione di conformità

Con la presente Gimeg Nederland B.V. dichiara che il dispositivo MCCHD 33, MCCHD 45 e MCCHD 60 applica tutti i requisiti di base e altri regolamenti pertinenti elencati nella Direttiva europea per la compatibilità elettromagnetica (2014/30/EU) e nella Direttiva sulla bassa tensione (2014/35/EU). Se si necessita di una dichiarazione di conformità completa, è possibile contattare l'indirizzo indicato sul retro del presente manuale.

	mestic		mestic		mestic	
	Product name	Coolerbox	Product name	Coolerbox	Product name	Coolerbox
<p>Gimeg Nederland BV Strijkviertel 27 3454 PH De Meern The Netherlands</p>	Item number	MCCHD-33	Item number	MCCHD-45	Item number	MCCHD-60
	Volume	31 L	Volume	43 L	Volume	56 L
	Climate classification	T- ST- SN- N	Climate classification	T- ST- SN- N	Climate classification	T- ST- SN- N
	Insulation class	◆	Insulation class	◆	Insulation class	◆
	Net weight	15.7 kg	Net weight	17.2 kg	Net weight	19 kg
	Rated Voltage DC	12V/24V	Rated Voltage DC	12V/24V	Rated Voltage DC	12V/24V
	Rated Current for DC	7.0A/3.5A	Rated Current for DC	7.0A/3.5A	Rated Current for DC	7.0A/3.5A
	Total Input Power	60W	Total Input Power	60W	Total Input Power	60W
	Refrigerant	R134a (40g)	Refrigerant	R134a (50g)	Refrigerant	R134a (60g)
	CO ₂ equiv.	0.057t	CO ₂ equiv.	0.072t	CO ₂ equiv.	0.086t
Foam Vesicant	C-Pentane	Foam Vesicant	C-Pentane	Foam Vesicant	C-Pentane	
Order number	INK-024395	Order number	INK-024395	Order number	INK-024395	
	Made in China		Made in China		Made in China	

DANSK

Funktioner

1. Håndtag på låget
2. Skærm
3. Håndtag
4. Kabelforbindelse
5. Ventilation



Levering

1. Køleboks
2. Tilslutningskabel til 12V/24V DC
3. Instruktionsmanual

Tilbehør (ikke inkluderet)

1502950 Mestic AC-adapter (220-240)

Generelle sikkerhedsinstruktioner

Læs betjeningsvejledningen omhyggeligt, før apparatet tages i brug, og gem instruktionerne inklusive garantien, kvitteringen og, hvis det er muligt, kassen med den interne emballage. Hvis du giver denne enhed til andre mennesker, skal du også videregive betjeningsvejledningen.

Generel sikkerhed:

- Læs vejledningen før brug.
- Hvis betingelserne ikke overholdes, er producenten ikke ansvarlig for ejendomsskader eller personskader som følge af brugen af denne enhed.
- Gem vejledningen, garantibeviset og salgskvitteringen.
- Brug af denne enhed er ikke tilladt for små børn. Enheden skal være under konstant opsyn under brug.
- Børn skal holdes under opsyn for at sikre, at de ikke leger med enheden.
- Denne enhed er ikke beregnet til brug af børn op til 8 år og personer med begrænsede fysiske, sensoriske eller mentale evner eller utilstrækkelig erfaring og viden, medmindre de er under opsyn eller har modtaget instruktioner om, hvordan enheden skal bruges af en person, som er ansvarlig for deres sikkerhed.
- Enheden skal altid stå på en plan, stabil og tør overflade.
- Brug aldrig apparatet, hvis der er synlige skader eller brud på kablet.
- I tilfælde af beskadigelse af apparatet, ledningen eller stikket må du aldrig selv foretage reparationer. Lad altid dette blive udført af producenten eller en kvalificeret tekniker.
- Enheden er ikke egnet til kommerciel brug.
- Brug og opbevar altid enheden på et tørt sted.
- Brug aldrig tilbehør, der ikke anbefales af producenten.
- Denne enhed er kun egnet til husholdningsbrug og til det formål, det er beregnet til.

Sikkerhed under brug:

- Tag altid stikket ud af enheden, hvis den skal vedligeholdes eller rengøres.
- Brug aldrig enheden i nærheden af varme genstande.
- Undgå, at enheden kommer i kontakt med regn.
- Anbring ikke andre elektriske enheder i enheden.
- Anbring ikke kemiske eller eksplosive midler i enheden.
- Brug kun DC 12V eller 230V-tilslutningskablet (medfølger ikke). BEMÆRK: Brug aldrig begge energikilder på samme tid.
- Afrim enheden regelmæssigt for at sikre, at enheden fungerer optimalt.
- Træk ikke i tilslutningsledningen, men træk i stikket for at tage ledningen ud af stikkontakten.
- Hvis køleboksen er tilsluttet DC-stikket, skal du afbryde køleboksen og andre enheder fra batteriet, før du tilslutter en hurtigoplader
- Hvis køleboksen er tilsluttet DC-stikket skal du slukke køleboksen eller afbryd forbindelsen, når du slukker motoren. Ellers kan batteriet blive afladet.
- Vær opmærksom! Den varme, der opstår under køleboksens drift, skal kunne spredes ordentligt.
- Der skal være en tilstrækkelig afstand mellem produkt og genstande og vægge.
- Nedsænk aldrig enheden i vand.
- Ventilationsåbningerne må aldrig tildækkes.

Brug

- Fjern alt emballagemateriale fra enheden.
- Anbring enheden på en flad og stabil overflade med mindst 10 cm fri plads på hver side.
- Tænd ikke for apparatet umiddelbart efter du har transporteret det, hvis køleboksen er blevet vippet mere end -30 °. Dette kan medføre skade på kølesystemet. Enheden skal først stå oprejst i 30 minutter, så kølevæsken kan opsamles igen i kompressoren. Dette forhindrer, at kompressoren kører tør.
- Se ovenstående brugerbetjening før brug.
- Af hygiejniske årsager skal du rengøre apparatets inderside og yderside med en fugtig klud, inden du bruger køleboksen. (se afsnit
- Tilslut køleboksen.

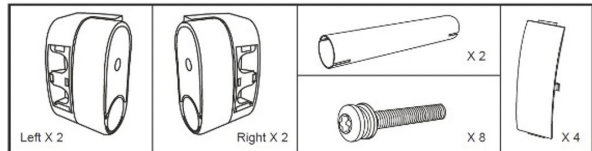
Montering af håndtag

step 1

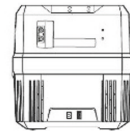
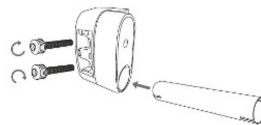

step 2

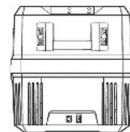
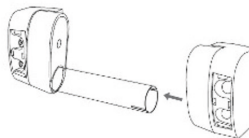

step 3

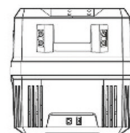
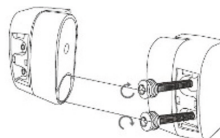

Kontrol

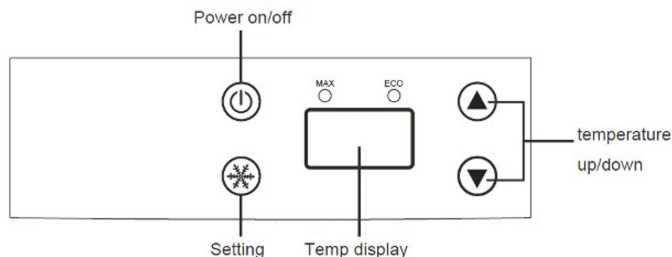

1. Tænd og sluk: tryk og hold tænd/sluk-knappen nede, køleskabet starter eller slukker
2. Temperaturjustering: tryk på knappen ▲ eller ▼ or at justere temperaturen. Temperaturen er nu indstillet.
3. Hurtig køling/energibesparende tilstand: Tryk på indstillingsknappen ⊗ for hurtigt at skifte mellem køletilstanden MAX og den energibesparende tilstand ECO. Grøn er Eco, og blå er MAX
4. Skift fra C til F: I standbytilstand skal du holde knapperne "⊗" og "▲" nede i 3 sekunder for at skifte mellem Fahrenheit og Celsius (F er Fahrenheit, C er Celsius). Når knappen har været sluppet i 3 sekunder, gemmes indstillingen automatisk.
5. USB-ladeport: I standbytilstand skal du trykke på "⊗" og "⊗" i 3 sekunder på samme tid for at gå ind i menuen til indstilling af batteribeskyttelsesudstyr, og derefter trykke på "▲" eller "▼" for at indstille den tilsvarende batteribeskyttelse

Detektering af batteristrøm

Enheden har en batteribeskyttelse på flere niveauer, der beskytter dit bilbatteri mod overdreven afladning, når enheden er sluttet til den indbyggede jævnstrømforsyning. Hvis køleren betjenes, mens køretøjets tænding er slukket, slukker køleren automatisk, når strømforsyningsspændingen falder under et indstillet niveau. Køleren tændes igen, når batteriet er blevet opladet til genstartspændingsniveauet. Kompressoren genstarter automatisk inden for et par minutter, når spændingen vender tilbage til normale værdier.

Bemærk: Disse værdier måles ved indgangen på styreenheden og/eller ved DC-forbindelsen.

1. Batteribeskyttelsesfunktionen til køleren kan automatisk kontrollere køretøjets batterispænding, inden elforbruget påvirker bilens normale funktioner. Køleboksen stopper automatisk for at sikre, at bilens batteri ikke løber tør.
2. Metode til justering af batteribeskyttelse:

Spænding / Beskyttelse	12 V		24 V	
	Cut off (V)	Cut in (V)	Cut off (V)	Cut in (V)
Low (Lav)	9,6 V	10,9 V	21,3 V	22,7 V
Mellem	10,4 V	11,7 V	22,8 V	24,2 V
High (Høj)	11,1 V	12,4 V	24,3 V	25,7 V

Tip:

Det anbefales at indstille H-klassen, når køleboksen er tilsluttet et køretøj, ellers kan bilens batteri være for tomt og påvirke bilens normale tænding. Når køleboksen tilsluttes et eksternt eller backupbatteri, anbefales det at indstille M-midterområdet, så køleboksen kan fungere i længere tid.

Betydningen af fejlkoden på skærmen og hvordan man håndterer den:

E1	Batterispændingen er lav
E2	Fejl i blæser
E3	Startproblemer i kompressor
E4	Kompressorens kørehastighed når ikke kravene
E5	Modellen er overophedet
E6	Modulfejll
E7	Fejl i det termiske hoved (åben eller kortslutning)

Rengøring

- Inden rengøring skal du fjerne produkterne fra enheden og fjerne stikket fra strømforsyningen. Rengør kun med en let fugtig klud. Om nødvendigt kan der anvendes et ikke-slibende rengøringsmiddel. Efter rengøring skal du altid tørre alle våde overflader med en tør klud.
- Brug aldrig skarpe eller slibende produkter til at rengøre enheden
- Afrim køleboksen: frost kan sætte sig på fordampere eller inde i køleboksen på grund af fugtighed, og dette kan reducere kølekapaciteten. Køleboksen skal afrimes i tide. Som følger:
 - Tag produkterne ud af køleboksen
 - Sluk for enheden
 - Åbn låget
 - Tør det smeltede vand op, eller tøm det smeltede vand ud gennem afløbet.



Genbrug

Dette produkt bærer det selektive sorteringssymbol for bortskaffelse af elektrisk og elektronisk udstyr. Det betyder, at dette produkt skal håndteres i henhold til EU-direktiv (2012/19/EU) for at blive genbrugt eller demonteret for at minimere dets påvirkning af miljøet. For yderligere information kan du kontakte dine lokale eller regionale myndigheder. Elektroniske produkter, der ikke indgår i den selektive sorteringsproces, er potentielt farlige for miljøet og helbredet på grund af tilstedeværelsen af farlige stoffer.

Overensstemmelseserklæring

Herved erklærer Gimeg Nederland B.V., at enheden MCCHD 33, MCCHD 45 & MCCHD 60 følger alle grundlæggende krav og andre relevante forskrifter, der er anført i det europæiske direktiv for elektromagnetisk kompatibilitet (2014/30/EU) og lavspændingsdirektivet (2014/35/EU). Hvis du har brug for en fuldstændig overensstemmelseserklæring, kan du kontakte adressen angivet på bagsiden af denne vejledning

	mestic		mestic		mestic																																																																																	
	<table border="1"> <tr><td>Product name</td><td>Coolerbox</td></tr> <tr><td>Item number</td><td>MCCHD-33</td></tr> <tr><td>Volume</td><td>31 L</td></tr> <tr><td>Climate classification</td><td>T- ST- SN- N</td></tr> <tr><td>Insulation class</td><td>◇</td></tr> <tr><td>Net weight</td><td>15.7 kg</td></tr> <tr><td>Rated Voltage DC</td><td>12V/24V ---</td></tr> <tr><td>Rated Current for DC</td><td>7.0A/3.5A</td></tr> <tr><td>Total Input Power</td><td>60W</td></tr> <tr><td>Refrigerant</td><td>R134a (40g)</td></tr> <tr><td>CO₂equiv.</td><td>0.057t</td></tr> <tr><td>Foam Vesicant</td><td>C-Pentane</td></tr> <tr><td>Order number</td><td>INK-024395</td></tr> <tr><td colspan="2">Made in China</td></tr> </table>	Product name	Coolerbox	Item number	MCCHD-33	Volume	31 L	Climate classification	T- ST- SN- N	Insulation class	◇	Net weight	15.7 kg	Rated Voltage DC	12V/24V ---	Rated Current for DC	7.0A/3.5A	Total Input Power	60W	Refrigerant	R134a (40g)	CO ₂ equiv.	0.057t	Foam Vesicant	C-Pentane	Order number	INK-024395	Made in China		<table border="1"> <tr><td>Product name</td><td>Coolerbox</td></tr> <tr><td>Item number</td><td>MCCHD-45</td></tr> <tr><td>Volume</td><td>43 L</td></tr> <tr><td>Climate classification</td><td>T- ST- SN- N</td></tr> <tr><td>Insulation class</td><td>◇</td></tr> <tr><td>Net weight</td><td>17.2 kg</td></tr> <tr><td>Rated Voltage DC</td><td>12V/24V ---</td></tr> <tr><td>Rated Current for DC</td><td>7.0A/3.5A</td></tr> <tr><td>Total Input Power</td><td>60W</td></tr> <tr><td>Refrigerant</td><td>R134a (50g)</td></tr> <tr><td>CO₂equiv.</td><td>0.072t</td></tr> <tr><td>Foam Vesicant</td><td>C-Pentane</td></tr> <tr><td>Order number</td><td>INK-024395</td></tr> <tr><td colspan="2">Made in China</td></tr> </table>	Product name	Coolerbox	Item number	MCCHD-45	Volume	43 L	Climate classification	T- ST- SN- N	Insulation class	◇	Net weight	17.2 kg	Rated Voltage DC	12V/24V ---	Rated Current for DC	7.0A/3.5A	Total Input Power	60W	Refrigerant	R134a (50g)	CO ₂ equiv.	0.072t	Foam Vesicant	C-Pentane	Order number	INK-024395	Made in China		<table border="1"> <tr><td>Product name</td><td>Coolerbox</td></tr> <tr><td>Item number</td><td>MCCHD-60</td></tr> <tr><td>Volume</td><td>56 L</td></tr> <tr><td>Climate classification</td><td>T- ST- SN- N</td></tr> <tr><td>Insulation class</td><td>◇</td></tr> <tr><td>Net weight</td><td>19 kg</td></tr> <tr><td>Rated Voltage DC</td><td>12V/24V ---</td></tr> <tr><td>Rated Current for DC</td><td>7.0A/3.5A</td></tr> <tr><td>Total Input Power</td><td>60W</td></tr> <tr><td>Refrigerant</td><td>R134a (60g)</td></tr> <tr><td>CO₂equiv.</td><td>0.086t</td></tr> <tr><td>Foam Vesicant</td><td>C-Pentane</td></tr> <tr><td>Order number</td><td>INK-024395</td></tr> <tr><td colspan="2">Made in China</td></tr> </table>	Product name	Coolerbox	Item number	MCCHD-60	Volume	56 L	Climate classification	T- ST- SN- N	Insulation class	◇	Net weight	19 kg	Rated Voltage DC	12V/24V ---	Rated Current for DC	7.0A/3.5A	Total Input Power	60W	Refrigerant	R134a (60g)	CO ₂ equiv.	0.086t	Foam Vesicant	C-Pentane	Order number	INK-024395	Made in China
Product name	Coolerbox																																																																																					
Item number	MCCHD-33																																																																																					
Volume	31 L																																																																																					
Climate classification	T- ST- SN- N																																																																																					
Insulation class	◇																																																																																					
Net weight	15.7 kg																																																																																					
Rated Voltage DC	12V/24V ---																																																																																					
Rated Current for DC	7.0A/3.5A																																																																																					
Total Input Power	60W																																																																																					
Refrigerant	R134a (40g)																																																																																					
CO ₂ equiv.	0.057t																																																																																					
Foam Vesicant	C-Pentane																																																																																					
Order number	INK-024395																																																																																					
Made in China																																																																																						
Product name	Coolerbox																																																																																					
Item number	MCCHD-45																																																																																					
Volume	43 L																																																																																					
Climate classification	T- ST- SN- N																																																																																					
Insulation class	◇																																																																																					
Net weight	17.2 kg																																																																																					
Rated Voltage DC	12V/24V ---																																																																																					
Rated Current for DC	7.0A/3.5A																																																																																					
Total Input Power	60W																																																																																					
Refrigerant	R134a (50g)																																																																																					
CO ₂ equiv.	0.072t																																																																																					
Foam Vesicant	C-Pentane																																																																																					
Order number	INK-024395																																																																																					
Made in China																																																																																						
Product name	Coolerbox																																																																																					
Item number	MCCHD-60																																																																																					
Volume	56 L																																																																																					
Climate classification	T- ST- SN- N																																																																																					
Insulation class	◇																																																																																					
Net weight	19 kg																																																																																					
Rated Voltage DC	12V/24V ---																																																																																					
Rated Current for DC	7.0A/3.5A																																																																																					
Total Input Power	60W																																																																																					
Refrigerant	R134a (60g)																																																																																					
CO ₂ equiv.	0.086t																																																																																					
Foam Vesicant	C-Pentane																																																																																					
Order number	INK-024395																																																																																					
Made in China																																																																																						
<p>Gimeg Nederland BV Strijkviertel 27 3454 PH De Meern The Netherlands</p>																																																																																						

Funktioner

1. Lockhandtag
2. Skärm
3. Handtag
4. Kabelanslutning
5. Ventilation



Leverans

1. Kylbox
2. Anslutningskabel för 12V / 24V DC
3. Bruksanvisning

Tillbehör (ingår ej i leveransen)

1502950 Mestic nätadapter (220-240)

Allmänna säkerhetsanvisningar

Läs bruksanvisningen noga innan du tar apparaten i bruk och behåll instruktionerna inklusive garantin, kvittot och, om möjligt, lådan med den inre förpackningen. Om du ger bort denna apparat till andra personer, vänligen bifoga också bruksanvisningen.

Allmän säkerhet:

- Läs bruksanvisningen före användning.
- Om användningsvillkoren inte följs ansvarar tillverkaren inte för förlust eller skada som uppstår till följd av användning av denna apparat.
- Spara manualen, garantibeviset och försäljningskvittot.
- Användning av denna produkt är inte tillåten för små barn. Under användning måste någon ständigt ha uppsikt.
- Barn måste övervakas för att säkerställa att de inte leker med apparaten.
- Denna apparat är inte avsedd att användas av barn upp till 8 år och personer med begränsade fysiska, sensoriska eller mentala förmågor eller otillräcklig erfarenhet och kunskap, såvida de inte övervakas eller har fått instruktioner om hur de ska använda apparaten av en ansvarig person för deras säkerhet.
- Apparaten måste alltid placeras på en plan, stabil och torr yta.
- Använd aldrig apparaten om den är synligt skadad eller om det finns brott på sladden.
- Vid skador på apparaten, sladden eller kontakten ska du aldrig utföra reparationer själv. Låt alltid detta utföras av tillverkaren eller av en kvalificerad tekniker.
- Apparaten är inte lämplig för kommersiellt bruk.
- Använd och förvara alltid apparaten på en torr plats.
- Använd aldrig tillbehör som inte rekommenderas av tillverkaren.
- Denna apparat är endast lämplig för hushållsbruk och för det ändamål som den är avsedd för.

Säkerhet vid användning;

- Ta alltid ur kontakten från apparaten när den behöver underhållas eller rengöras.
- Använd aldrig apparaten i närheten av hetta eller heta föremål.
- Förhindra att apparaten kommer i kontakt med regn.
- Placera inte andra elektriska artiklar i apparaten.
- Placera inte kemiska eller explosiva ämnen i apparaten.
- Använd endast DC 12V eller 230V anslutningskabel (ingår ej). OBS: använd aldrig båda energikällorna samtidigt.
- Frostas av apparaten regelbundet för att säkerställa att den fungerar optimalt.
- Dra inte i anslutningsladdan utan dra i kontakten för att ta bort sladden ur uttaget.
- Om kylboxen är ansluten till likspänningsuttaget, koppla bort kylboxen och andra förbrukare från batteriet innan du ansluter en snabbbladdare
- Om kylboxen är ansluten till likspänningsuttaget; stäng av kylboxen eller bryt anslutningen när du stänger av motorn. Annars kan batteriet urladdas
- Var uppmärksam på:! Att värmen som uppstår under drift av kylboxen kan avledas ordentligt.
- Att det är tillräckligt avstånd mellan apparaten och föremål och väggar.
- Sänk aldrig ned apparaten i vatten
- Att ventilationsluckorna aldrig är övertäckta.

Användning

- Ta bort allt förpackningsmaterial från apparaten.
- Placera apparaten på en plan och stabil yta med minst 10 cm ledigt utrymme på varje sida.
- Slå inte på apparaten direkt efter transporter, om kylboxen har lutats mer än -30 °. Detta kan orsaka skador på kylsystemet. Apparaten måste först stå upprätt i 30 minuter så att kylvätskan kan samlas upp igen i kompressorn. Detta förhindrar att kompressorn går torr.
- Titta på ovanstående användarvillkor före användning.
- Av hygieniska skäl måste du rengöra apparatens insida och utsida med en fuktig trasa innan användning. (se avsnitt
- Anslut kylboxen.

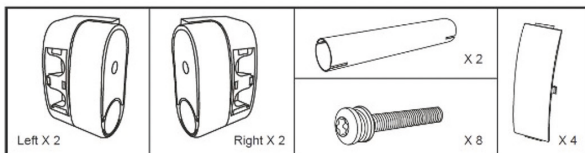
Montering av handtag

step 1

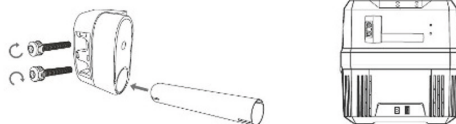

step 2

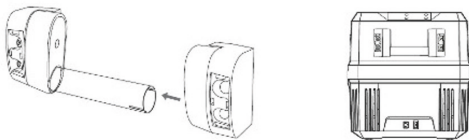

step 3

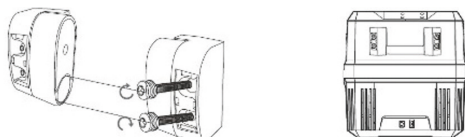

Kontrollera

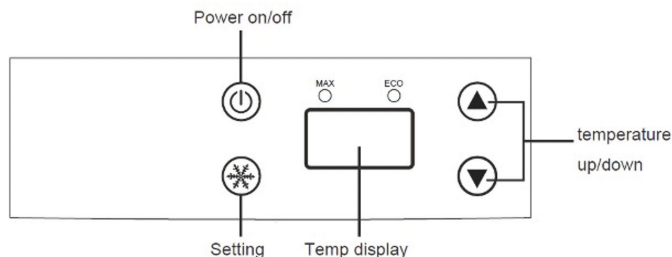

1. Slå på och av: håll in på / av-knappen, kylboxen startar eller stängs av
2. Temperaturjustering: tryck på ▲ eller ▼-knappen för att justera temperaturen. Temperaturen är nu inställd.
3. Snabbkylning / energisparläge: tryck på set -knappen ⊗ för att snabbt växla mellan kylningsläge MAX och energisparläge ECO. Grönt är ECO och blått är MAX
4. Byt C till F: I viloläge håller du ned "⊕" och "⊖" -knappen i 3 sekunder för att växla mellan Fahrenheit och Celsius temperatur (F är Fahrenheit temperatur, C är Celsius temperatur), 3 sekunder efter att knappen släpps sparas inställningen automatiskt och stängs.
5. USB-laddningsport: I viloläge tryck på "⏻" och "⊕" i 3 sekunder samtidigt för att komma till inställningsmenyn för batteriskydd, och tryck sedan på "▲" eller "▼" för att ställa in motsvarande batteriskydd

Detektering av batterinivå

Apparaten har ett batteriskydd i flera nivåer som skyddar ditt fordonsbatteri från alltför stor urladdning när apparaten är ansluten till den inbyggda DC-strömförsörjningen. Om kylboxen drivs med fordonets tändning avstängd, stängs kylboxen

av automatiskt när nätspänningen sjunker under en inställd nivå. Kylaren slås på igen när

batteriet laddas till spänningsnivån för omstart. Kompressorn startar om automatiskt efter några minuter när spänningen återgår till normala värden.

Obs! Dessa värden mäts vid styrenhetens ingång och / eller vid likströmsanslutningen.

1. Batteriskyddsfunktion för kylaren med treklassig batteriskyddsfunktion, kan automatiskt kontrollera fordonets batterispänning innan elförbrukningen påverkar bilens normala funktioner. Kylboxen stannar automatiskt för att säkerställa att bilens batteri inte tar slut.
2. Metod för justering av batteriskyddet:

Spänning / Skydd	12 V		24 V	
	Cut off (V)	Cut in (V)	Cut off (V)	Cut in (V)
Låg	9,6 V	10,9 V	21,3 V	22,7 V
Medelstor	10,4 V	11,7 V	22,8 V	24,2 V
Hög	11,1 V	12,4 V	24,3 V	25,7 V

Tips:

Det rekommenderas att ställa in H-klass när kylboxen är ansluten till ett fordon, annars kan bilens batteri bli alltför urladdat och påverka bilens normala tändning. När kylboxen ansluts till ett externt batteri eller ett reservbatteri rekommenderas att ställa in M-mid-intervallet så att kylboxen kan fungera längre.

Betydelsen av felkoden på skärmen och hur man hanterar den:

E1	Batterispänningen är låg
E2	Fläktfel
E3	Uppstartproblem hos kompressorn
E4	Kompressorns körhastighet når inte kraven
E5	Modellen överhettas
E6	Modulfel
E7	Termiskt huvudfel (öppen krets eller kortslutning)

Rengöring

- Innan rengöring, ta bort produkterna från apparaten och ta ut kontakten från strömförsörjningen. Rengör endast med en lätt fuktad trasa, vid behov kan ett icke-aggressivt rengöringsmedel användas. Efter rengöring, torka alltid alla våta ytor med en torr trasa.
- Använd aldrig vassa eller slipande produkter för att rengöra enheten.
- Frosta av kylboxen: frost kan sätta sig på förångaren eller på kylboxens insida på grund av fukt, något som kan minska kylkapaciteten. Kylboxen måste frostas av i tid. På följande sätt
 - Ta ut matvarorna ur kylboxen
 - Stäng av apparaten
 - Öppna locket
 - Samla upp smältvattnet eller töm smältvattnet genom pluggen.

**Återvinning**

Denna produkt har symbolen för avfallssortering som elektrisk och elektronisk utrustning. Detta innebär att denna produkt måste hanteras i enlighet med EU-direktiv (2012/19/EU) för att kunna återvinnas eller demonteras för att minimera dess påverkan på miljön. För mer information, kontakta dina lokala eller regionala myndigheter. Elektroniska produkter som inte ingår i sorteringsprocessen för avfall är potentiellt farliga för miljön och människors hälsa på grund av förekomsten av farliga ämnen.

Försäkran om överensstämmelse

Härmed förklarar Gimeg Nederland B.V. att enheten MCCHD 33, MCCHD 45 & MCCHD 60, uppfyller alla grundläggande krav och andra relevanta föreskrifter som anges i det europeiska direktivet om elektromagnetisk kompatibilitet (2014/30/EU) och lågspänningsdirektivet (2014/35/EU). Om du behöver en fullständig försäkran om överensstämmelse kan du kontakta adressen som anges på baksidan av denna bruksanvisning

	mestic		mestic		mestic	
	Product name	Coolerbox	Product name	Coolerbox	Product name	Coolerbox
Item number	MCCHD-33	Item number	MCCHD-45	Item number	MCCHD-60	
Volume	31 L	Volume	43 L	Volume	56 L	
Climate classification	T. ST. SN. N	Climate classification	T. ST. SN. N	Climate classification	T. ST. SN. N	
Insulation class	◊	Insulation class	◊	Insulation class	◊	
Net weight	15.7 kg	Net weight	17.2 kg	Net weight	19 kg	
Rated Voltage DC	12V/24V ---	Rated Voltage DC	12V/24V ---	Rated Voltage DC	12V/24V ---	
Rated Current for DC	7.0A/3.5A	Rated Current for DC	7.0A/3.5A	Rated Current for DC	7.0A/3.5A	
Total Input Power	60W	Total Input Power	60W	Total Input Power	60W	
Refrigerant	R134a (40g)	Refrigerant	R134a (50g)	Refrigerant	R134a (60g)	
CO ₂ equiv.	0.057t	CO ₂ equiv.	0.072t	CO ₂ equiv.	0.086t	
Foam Vesicant	C-Pentane	Foam Vesicant	C-Pentane	Foam Vesicant	C-Pentane	
Order number	INK-024395	Order number	INK-024395	Order number	INK-024395	
Gimeg Nederland BV Strijkviertel 27 3454 PH De Meern The Netherlands		Made in China		Made in China		

NORSK

Funksjoner

1. Lokkhåndtak
2. Skjerm
3. Håndtak
4. Ledningstilkobling
5. Ventilasjon



Levering

1. Kjøleboks
2. Tilkoblingsledning for 12V / 24V DC
3. Instruksjonshåndbok

Tilbehør (ikke inkludert i forsendelsen)

1502950 Mestic AC-adapter (220-240)

Generelle sikkerhetsinstruksjoner

Les bruksanvisningen nøye før du tar apparatet i bruk og ta vare på instruksjonene, inkludert garantien, kvitteringen og om mulig esken med den interne emballasjen. Hvis du gir denne enheten til andre, gi også bruksanvisningen videre.

Generell sikkerhet:

- Les håndboken før bruk.
- Hvis bruksvilkårene ikke er overholdt, er produsenten ikke ansvarlig for skader eller personskader som følge av bruk av denne enheten.
- Lagre manualen, garantibeviset og salgskvitteringen.
- Bruk av denne enheten er ikke tillatt for små barn. Under bruk må noen hele tiden føre tilsyn.
- Barn må være under oppsyn for å sikre at de ikke leker med enheten.
- Denne enheten er ikke beregnet for bruk av barn under 8 år og personer med begrensede fysiske, sensoriske eller mentale evner eller utilstrekkelig erfaring og kunnskap, med mindre de er under oppsyn eller har mottatt instruksjoner om hvordan den skal brukes av en person som er ansvarlig for deres sikkerhet.
- Enheten må alltid være på en flat, stabil og tørr overflate.
- Bruk aldri apparatet hvis det er synlig skadet eller hvis det er brudd på ledningen.
- Ved skader på apparatet, ledningen eller støpselet må du aldri utføre reparasjoner selv. La alltid dette gjøres av produsenten eller en kvalifisert tekniker.
- Enheten er ikke egnet for kommersiell bruk.
- Bruk og oppbevar alltid enheten på et tørt sted.
- Bruk aldri tilbehør som ikke er anbefalt av produsenten.
- Denne enheten er bare egnet for husholdningsbruk og for formålet den er beregnet på.

Sikkerhet ved bruk;

- Fjern alltid støpselet fra enheten når den må vedlikeholdes eller rengjøres.
- Bruk aldri enheten i nærheten av varme eller varme gjenstander.
- Unngå at enheten kommer i kontakt med regn.
- Ikke plasser andre elektriske enheter i enheten.
- Ikke plasser kjemiske eller eksplosive midler i enheten.
- Bruk bare DC 12V eller 230V tilkoblingskabelen (ikke inkludert). MERK: Bruk aldri begge energikildene samtidig.
- Tin enheten regelmessig for å sikre at enheten fungerer optimalt.
- Ikke dra i tilkoblingsledningen, men trekk i kontakten for å fjerne ledningen fra kontakten.
- Hvis kjøleboksen er koblet til DC-kontakten, må du koble kjøleboksen og andre forbrukere fra batteriet før du kobler til en hurtiglader
- Hvis kjøleboksen er koblet til DC-kontakten; slå av kjøleboksen eller bryt tilkoblingen når du slår av motoren. Ellers kan batteriet lades ut.
- Følg med! At varmen som oppstår under drift av kjøleboksen kan skikkelig avledes.
- Nok avstand mellom produktet og gjenstander og vegger.
- Senk aldri enheten ned i vann
- Ventilasjonsåpninger er ikke dekket til enhver tid.

Bruk

- Fjern alt emballasjemateriale fra enheten.
- Plasser enheten på en flat og stabil overflate med minst 10 cm ledig plass på hver side.
- Ikke slå på apparatet umiddelbart etter at du har transportert det, der kjøleboksen har vippet mer enn -30° . Dette kan forårsake skade på kjølesystemet. Enheten må først stå oppreist i 30 minutter, slik at kjølevæsken kan samles igjen i kompressoren. Dette forhindrer at kompressoren går tørr.
- Se på brukerbetingelsene ovenfor før bruk.
- Av hygieniske årsaker må du rengjøre innsiden og utsiden av apparatet med en fuktig klut før du bruker kjøleboksen. (se avsnitt
- Koble kjøleboksen.

Installere håndtak

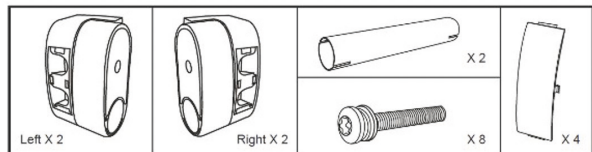

step 1

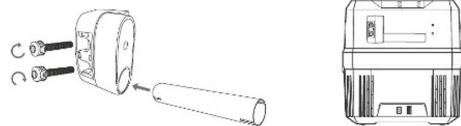

step 2

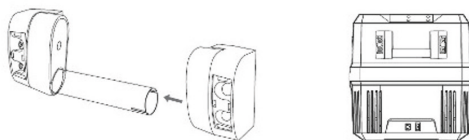

step 3

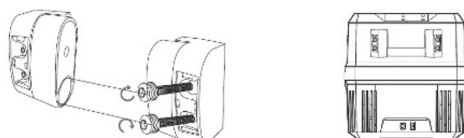

Kontroll

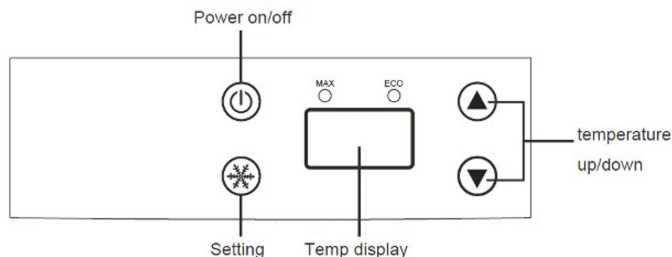

1. Slå av og på: Trykk og hold inne på / av -knappen, kjøleskapet starter nå eller slår seg av
2. Temperaturjustering: trykk på ▲ eller ▼ for å justere temperaturen. Temperaturen er nå innstilt.
3. Hurtigkjøling / energisparemodus: Trykk på set -knappen ⊗ for raskt å bytte mellom kjølemodus MAX og energisparemodus ECO. Grønt er Eco og blått er MAX
4. Bytt C til F: I standby -modus holder du nede "⊗" og "▲"-tasten i 3 sekunder for å bytte temperatur mellom Fahrenheit og Celsius (F er Fahrenheit -temperatur, C er Celsius-temperatur), etter at tasten slippes i 3 sekunder, automatisk lagrer innstillingen og avslutter.
5. USB ladeport: Trykk på i standby-tilstand "⌏" og "⊗" i 3 sekunder samtidig for å gå til innstillingsmenyen for batteribeskyttelsesutstyr, og trykk deretter på "▲" eller "▼" for å stille inn tilsvarende batteribeskyttelse

Batterideteksjon

Enheten har en batterivakt på flere nivåer som beskytter bilbatteriet mot overdreven utladning når enheten er koblet til den innebygde likestrømforsyningen. Hvis kjøleren brukes med tenningen av kjøretøyet, kjøleren vil slå seg av automatisk når strømforsyningsspenningen faller under et angitt nivå. Kjøleboksen slår seg på igjen straks batteriet er ladet til omstartspenningsnivået. Kompressoren starter automatisk på nytt om noen få minutter når spenningen går tilbake til normale verdier.

Merk: Disse verdiene måles ved inngangen til kontrollenheten og / eller ved likestrømtilkoblingen.

1. Batteribeskyttelsesfunksjon for kjøleren med tre-klasse batteribeskyttelsesfunksjon, kan automatisk kontrollere batterispenningen til kjøretøyet, før strømforsyningen vil påvirke bilens normale funksjoner. Kjøleboksen stopper automatisk for å sikre at bilens batteri ikke blir tomt.
2. Metode for å justere batteribeskyttelsen:

Spenning / Beskyttelse	12 V		24 V	
	Kutt av (V)	Kutt inn (V)	Kutt av (V)	Kutt inn (V)
Lav	9,6 V	10,9 V	21,3 V	22,7 V
Middels	10,4 V	11,7 V	22,8 V	24,2 V
Høy	11,1 V	12,4 V	24,3 V	25,7 V

Tips:

Det anbefales å stille H-lassen når kjøleboksen er koblet til et kjøretøy, ellers kan bilens batteri være for tomt og påvirke bilens normale tenning; Når du kobler kjøleboksen til et eksternt eller reservebatteri, anbefales det å stille inn M-mid-området slik at kjøleboksen kan fungere lenger.

Betydningen av feilkoden på skjermen og hvordan du skal håndtere den:

E1	Batterispenningen er lav
E2	Viftefeil
E3	Problemer med oppstart av kompressor
E4	Kompressorens kjørehastighet når ikke kravene
E5	Modellen er overopphetet
E6	Modulfeil
E7	Termisk hodefeil (åpen krets eller kortslutning)

Rengjøring

- Før rengjøring, fjern produktene fra enheten og fjern støpselet fra strømforsyningen. Rengjør bare med en lett fuktig klut, og nødvendig kan et ikke-aggressivt rengjøringsmiddel brukes. Etter rengjøring må du alltid tørke alle våte overflater med en tørr klut.
- Bruk aldri skarpe eller slipende produkter for å rengjøre enheten.
- Tin kjøleboksen: frost kan sette seg på fordampere eller inne i kjøleboksen på grunn av fuktighet, dette kan redusere kjølekapasiteten. Kjøleboksen må tines i tide. Følgende
 - Ta produktene ut av kjøleboksen
 - Slå av enheten
 - Åpne lokket
 - Sveip opp smeltevannet eller tøm smeltevannet gjennom pluggen.

**Resirkulering**

Dette produktet har det selektive sorterings symbolet for elektrisk og elektronisk utstyr. Dette betyr at dette produktet må håndteres i henhold til europeisk direktiv (2012/19/EU) for å bli resirkulert eller demontert for å minimere miljøpåvirkningen. For mer informasjon, vennligst kontakt dine lokale eller regionale myndigheter. Elektroniske produkter som ikke er inkludert i kildesorteringsprosessen, er potensielt farlige for miljøet og menneskelig helse på grunn av tilstedeværelse av farlige stoffer.

Samsvarserklæring

Gimeg Nederland BV erklærer herved at enheten MCCHD 33, MCCHD 45 & MCCHD 60 bruker alle grunnleggende krav og andre relevante forskrifter som er oppført i det europeiske direktivet for elektromagnetisk kompatibilitet (2014/30/EU) og lavspenningsdirektiv (2014/35/EU). Hvis du trenger en fullstendig samsvarserklæring, kan du ta kontakt med adressen som står på baksiden av denne håndboken

	mestic		mestic		mestic	
	Product name	Coolerbox	Product name	Coolerbox	Product name	Coolerbox
	Item number	MCCHD-33	Item number	MCCHD-45	Item number	MCCHD-60
	Volume	31 L	Volume	43 L	Volume	56 L
Climate classification	T · ST · SN · N	Climate classification	T · ST · SN · N	Climate classification	T · ST · SN · N	
Insulation class	⊠	Insulation class	⊠	Insulation class	⊠	
Net weight	15.7 kg	Net weight	17.2 kg	Net weight	19 kg	
Rated Voltage DC	12V/24V ---	Rated Voltage DC	12V/24V ---	Rated Voltage DC	12V/24V ---	
Rated Current for DC	7.0A/3.5A	Rated Current for DC	7.0A/3.5A	Rated Current for DC	7.0A/3.5A	
Total Input Power	60W	Total Input Power	60W	Total Input Power	60W	
Refrigerant	R134a (40g)	Refrigerant	R134a (60g)	Refrigerant	R134a (60g)	
CO ₂ equiv.	0.057t	CO ₂ equiv.	0.072t	CO ₂ equiv.	0.086t	
Foam Vesicant	C-Pentane	Foam Vesicant	C-Pentane	Foam Vesicant	C-Pentane	
Order number	INK-024395	Order number	INK-024395	Order number	INK-024395	
Gimeg Nederland BV Strijkviertel 27 3454 PH De Meern The Netherlands		Made in China		Made in China		

mestic®

Importer:
Gimeg Nederland B.V.
Atoomweg 99, 3542 AA Utrecht
The Netherlands